

# ***SATA NAS SUBSYSTEM***

## ***Installation Reference Guide***

***Revision 1.1***

P/N: PW002000000196

## **Copyright**

No part of this publication may be reproduced, stored in a retrieval system, or transmitted in any form or by any means, electronic, mechanical, photocopying, recording or otherwise, without the prior written consent.

## **Trademarks**

All products and trade names used in this document are trademarks or registered trademarks of their respective holders.

## **Changes**

The material in this documents is for information only and is subject to change without notice.

## **FCC Compliance Statement**

This equipment has been tested and found to comply with the limits for a Class B digital device, pursuant to Part 15 of the FCC rules. These limits are designed to provide reasonable protection against harmful interference in residential installations. This equipment generates, uses, and can radiate radio frequency energy, and if not installed and used in accordance with the instructions, may cause harmful interference to radio communications. However, there is not guarantee that interference will not occur in a particular installation. If this equipment does cause interference to radio or television equipment reception, which can be determined by turning the equipment off and on, the user is encouraged to try to correct the interference by one or more of the following measures:

1. Reorient or relocate the receiving antenna
2. Move the equipment away from the receiver
3. Plug the equipment into an outlet on a circuit different from that to which the receiver is powered.
4. Consult the dealer or an experienced radio/television technician for help

All external connections should be made using shielded cables.



# Table of Contents

<b>Chapter 1</b>	<b>Introduction</b>	
1.1	Key Features.....	1-2
1.2	RAID Concepts.....	1-3
1.3	Array Definition.....	1-10
	1.3.1 RAID set.....	1-10
	1.3.2 Volume Set.....	1-10
	1.3.3 Easy of Use features.....	1-11
	1.3.4 High Availability.....	1-13
<b>Chapter 2</b>	<b>Installation Overview</b>	
2.1	Unpacking the subsystem.....	2-1
2.2	Identifying parts of the subsystem.....	2-3
	2.2.1 Front View .....	2-3
	2.2.2 Rear view .....	2-6
2.3	Connecting NAS subsystem to Your Network.....	2-8
2.4	Powering-on.....	2-8
2.5	Installing Hard Drives.....	2-9
2.6	Install OS.....	2-10
<b>Chapter 3</b>	<b>RAID Configuring</b>	
3.1	Configuring through a Terminal.....	3-1
3.2	Configuring the Subsystem Using the LCD Panel.....	3-9
	3.2.1 Menu Diagram.....	3-10
3.3	Web browser-based Remote RAID management via R-Link ethernet.....	3-15
3.4	Configuring through Web browser-based RAID management.....	3-16
3.5	Quick Create.....	3-19
3.6	Raid Set Functions.....	3-21
	3.6.1 Create Raid Set.....	3-21
	3.6.2 Delete Raid Set.....	3-22
	3.6.3 Expand Raid Set.....	3-23
	3.6.4 Activate Incomplete Raid Set.....	3-25
	3.6.5 Create Hot Spare.....	3-27
	3.6.6 Delete Hot Spare.....	3-27
	3.6.7 Rescue Raid Set.....	3-28
3.7	Volume Set Function.....	3-29
	3.7.1 Create Volume Set.....	3-29
	3.7.2 Delete Volume Set.....	3-32
	3.7.3 Modify Volume Set.....	3-33
	3.7.3.1 Volume Expansion.....	3-33
	3.7.4 Volume Set Migration.....	3-35
	3.7.5 Check Volume Set.....	3-36
	3.7.6 Stop Volume Set Check.....	3-36

3.8	Physical Drive.....	3-37
	3.8.1 Create Pass-Through Disk.....	3-37
	3.8.2 Modify Pass-Through Disk.....	3-38
	3.8.3 Delete Pass-Through Disk.....	3-39
	3.8.4 Identify Selected Drive.....	3-39
3.9	System Configuration.....	3-40
	3.9.1 System Configuration.....	3-40
	3.9.2 U320 SCSI Target Configuration.....	3-42
	3.9.3 Ethernet Config.....	3-43
	3.9.4 Alert By Mail Config.....	3-44
	3.9.5 SNMP Configuration.....	3-45
	3.9.6 View Events.....	3-46
	3.9.7 Generate Test Events.....	3-47
	3.9.8 Clear Events Buffer.....	3-48
	3.9.9 Modify Password.....	3-48
	3.9.10 Upgrade Firmware.....	3-49
3.10	Information Menu.....	3-50
	3.10.1 RaidSet Hierarchy.....	3-50
	3.10.2 System Information.....	3-50
	3.10.3 Hardware Monitor.....	3-51
3.11	Creating a new RAID or Reconfiguring an Existing RAID.....	3-52
3.12	Upgrading the Firmware.....	3-53

---

# **Chapter 1**

## **Introduction**

As network infrastructures become more and more complex, companies of all sizes are seeking easier, more cost-effective ways of managing data. The SN-3163 NAS SATA RAID subsystem offer the fast, scalable and reliable data management solutions overcome the challenges for sharing, managing, and protecting data in today's global, high-growth infrastructures.

The simple plug and play design allows installation right where the data is used, or in the main data center, without disrupting your servers. The SN-3163 NAS subsystem can boot without HDD, FDD or CD-ROM to guarantee reliability and quick boot. It is managed and configured by browser based software, including pre-configure disk capacity, users setting, volume management, quick installed on popular network platform, Multi protocol support, tape backup/restore etc..

The SN-3163 comes with 16 hot-swappable drive trays accommodating 3.5" SATA drives. It is equipped with RAID controllers to offer fault tolerant data protection. It is a full featured data protection supporting RAID levels 0, 1, 0+1, 3, 5, 6 and JBOD. Supporting hot spare, automatic hot rebuild and online capacity expansion within the enclosure.

---

## **1.1 Key Features**

- Configurable to 19" rack-mountable 3U chassis
- Supports up to sixteen(16) 1" hot-swappable SATA hard drives
- Support Tape/DAT backup/restore
- Supports RAID levels 0, 1, 0+1, 3, 5, 6 and JBOD
- Supports hot spare and automatic hot rebuild
- Smart-function LCD panel for RAID setting & ENC status
- Allows online capacity expansion within the enclosure
- Two Gigabit Ethernet ports

---

## **1.2 RAID Concepts**

### ***RAID Fundamentals***

The basic idea of RAID (Redundant Array of Independent Disks) is to combine multiple inexpensive disk drives into an array of disk drives to obtain performance, capacity and reliability that exceeds that of a single large drive. The array of drives appears to the host computer as a single logical drive.

Five types of array architectures, RAID 1 through RAID 6, were originally defined, each provides disk fault-tolerance with different compromises in features and performance. In addition to these five redundant array architectures, it has become popular to refer to a non-redundant array of disk drives as a RAID 0 array.

### ***Disk Striping***

Fundamental to RAID technology is striping. This is a method of combining multiple drives into one logical storage unit. Striping partitions the storage space of each drive into stripes, which can be as small as one sector (512 bytes) or as large as several megabytes. These stripes are then interleaved in a rotating sequence, so that the combined space is composed alternately of stripes from each drive. The specific type of operating environment determines whether large or small stripes should be used.

Most operating systems today support concurrent disk I/O operations across multiple drives. However, in order to maximize throughput for the disk subsystem, the I/O load must be balanced across all the drives so that each drive can be kept busy as much as possible. In a multiple drive system without striping, the disk I/O load is never perfectly balanced. Some drives will contain data files that are frequently accessed and some drives will rarely be accessed.

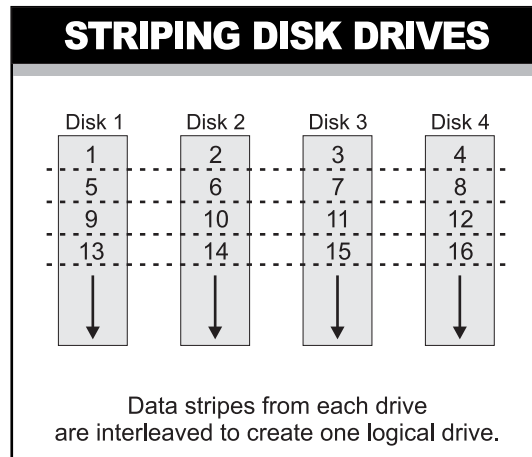

By striping the drives in the array with stripes large enough so that each record falls entirely within one stripe, most records can be evenly distributed across all drives. This keeps all drives in the array busy during heavy load situations. This situation allows all drives to work concurrently on different I/O operations, and thus maximize the number of simultaneous I/O operations that can be performed by the array.

### ***Definition of RAID Levels***

**RAID 0** is typically defined as a group of striped disk drives without parity or data redundancy. RAID 0 arrays can be configured with large stripes for multi-user environments or small stripes for single-user systems that access long sequential records. RAID 0 arrays deliver the best data storage efficiency and performance of any array type. The disadvantage is that if one drive in a RAID 0 array fails, the entire array fails.

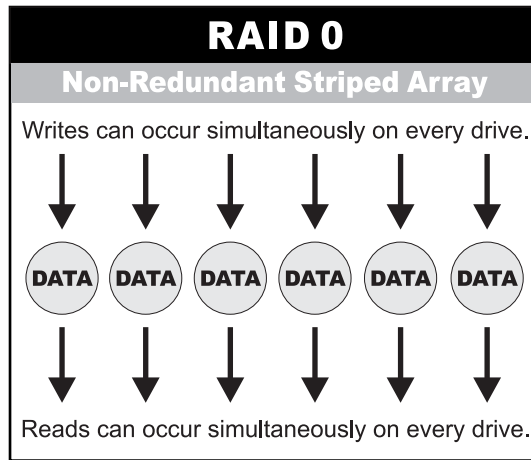

**RAID 1**, also known as disk mirroring, is simply a pair of disk drives that store duplicate data but appear to the computer as a single drive. Although striping is not used within a single mirrored drive pair, multiple RAID 1 arrays can be striped together to create a single large array consisting of pairs of mirrored drives. All writes must go to both drives of a mirrored pair so that the information on the drives is kept identical. However, each individual drive can perform simultaneous, independent read operations. Mirroring thus doubles the read performance of a single non-mirrored drive and while the write performance is unchanged. RAID 1 delivers the best performance of any redundant array type. In addition, there is less performance degradation during drive failure than in RAID 5 arrays.

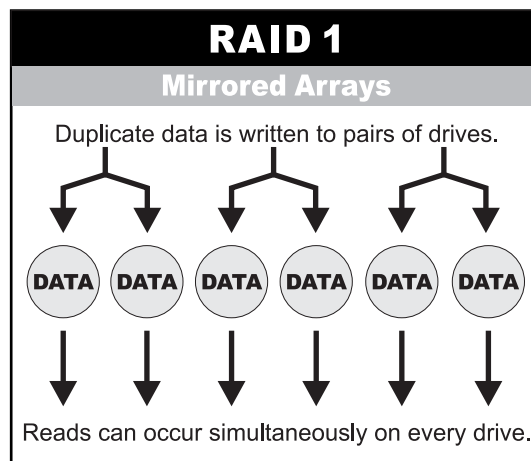

---

**RAID 3** sector-stripes data across groups of drives, but one drive in the group is dedicated to storing parity information. RAID 3 relies on the embedded ECC in each sector for error detection. In the case of drive failure, data recovery is accomplished by calculating the exclusive OR (XOR) of the information recorded on the remaining drives. Records typically span all drives, which optimizes the disk transfer rate. Because each I/O request accesses every drive in the array, RAID 3 arrays can satisfy only one I/O request at a time. RAID 3 delivers the best performance for single-user, single-tasking environments with long records. Synchronized-spindle drives are required for RAID 3 arrays in order to avoid performance degradation with short records. RAID 5 arrays with small stripes can yield similar performance to RAID 3 arrays.

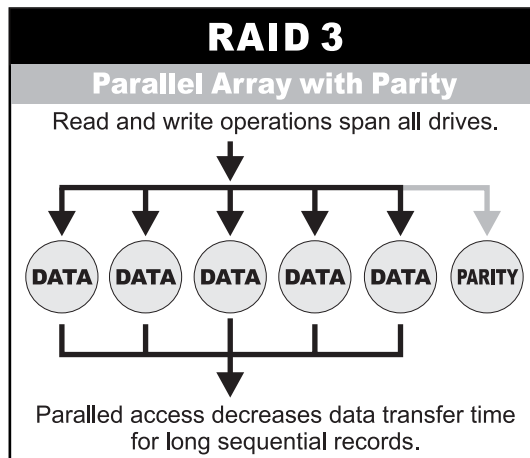

Under **RAID 5** parity information is distributed across all the drives. Since there is no dedicated parity drive, all drives contain data and read operations can be overlapped on every drive in the array. Write operations will typically access one data drive and one parity drive. However, because different records store their parity on different drives, write operations can usually be overlapped.

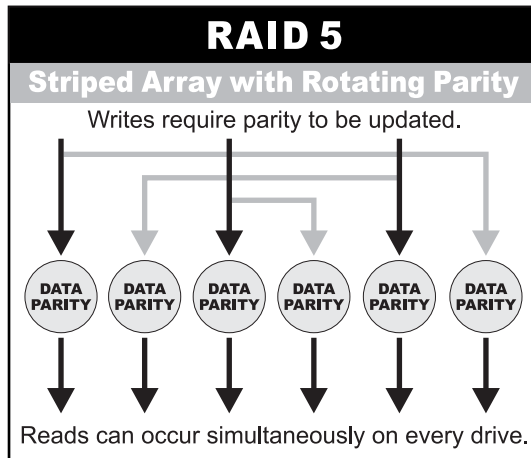

**RAID 6** is similar to RAID 5 in that data protection is achieved by writing parity information to the physical drives in the array. With RAID 6, however, **two** sets of parity data are used. These two sets are different, and each set occupies a capacity equivalent to that of one of the constituent drives. The main advantages of RAID 6 is High data availability – any two drives can fail without loss of critical data.

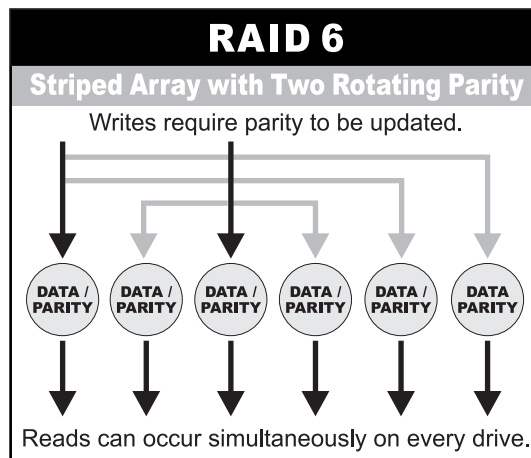

---

**Dual-level RAID** achieves a balance between the increased data availability inherent in RAID 1 and RAID 5 and the increased read performance inherent in disk striping (RAID 0). These arrays are sometimes referred to as **RAID 0+1** or RAID 10 and RAID 0+5 or RAID 50.

In summary:

- ❖ RAID 0 is the fastest and most efficient array type but offers no fault-tolerance. RAID 0 requires a minimum of two drives.
- ❖ RAID 1 is the best choice for performance-critical, fault-tolerant environments. RAID 1 is the only choice for fault-tolerance if no more than two drives are used.
- ❖ RAID 3 can be used to speed up data transfer and provide fault-tolerance in single-user environments that access long sequential records. However, RAID 3 does not allow overlapping of multiple I/O operations and requires synchronized-spindle drives to avoid performance degradation with short records. RAID 5 with a small stripe size offers similar performance.
- ❖ RAID 5 combines efficient, fault-tolerant data storage with good performance characteristics. However, write performance and performance during drive failure is slower than with RAID 1. Rebuild operations also require more time than with RAID 1 because parity information is also reconstructed. At least three drives are required for RAID 5 arrays.
- ❖ RAID 6 is essentially an extension of RAID level 5 which allows for additional fault tolerance by using a second independent distributed parity scheme (two-dimensional parity). Data is striped on a block level across a set of drives, just like in RAID 5, and a second set of parity is calculated and written across all the drives; RAID 6 provides for an extremely high data fault tolerance and can sustain multiple simultaneous drive failures. Perfect solution for mission critical applications.

---

## **RAID Management**

The subsystem can implement several different levels of RAID technology. RAID levels supported by the subsystem are shown below.

<b>RAID Level</b>	<b>Description</b>	<b>Min Drives</b>
0	Block striping is provide, which yields higher performance than with individual drives. There is no redundancy.	1
1	Drives are paired and mirrored. All data is 100% duplicated on an equivalent drive. Fully redundant.	2
3	Data is striped across several physical drives. Parity protection is used for data redundancy.	3
5	Data is striped across several physical drives. Parity protection is used for data redundancy.	3
6	Data is striped across several physical drives. Parity protection is used for data redundancy. Requires N+2 drives to implement because of two-dimensional parity scheme	4
0 + 1	Combination of RAID levels 0 and 1. This level provides striping and redundancy through mirroring.	4

---

## **1.3 Array Definition**

### **1.3.1 RAID Set**

A RAID Set is a group of disks containing one or more volume sets. It is impossible to have multiple RAID Sets on the same disks.

A Volume Set must be created either on an existing RAID set or on a group of available individual disks (disks that are not yet a part of an raid set). If there are pre-existing raid sets with available capacity and enough disks for specified RAID level desired, then the volume set will be created in the existing raid set of the user's choice. If physical disks of different capacity are grouped together in a raid set, then the capacity of the smallest disk will become the effective capacity of all the disks in the raid set.

### **1.3.2 Volume Set**

A Volume Set is seen by the host system as a single logical device. It is organized in a RAID level with one or more physical disks. RAID level refers to the level of data performance and protection of a Volume Set. A Volume Set capacity can consume all or a portion of the disk capacity available in a RAID Set. Multiple Volume Sets can exist on a group of disks in a RAID Set. Additional Volume Sets created in a specified RAID Set will reside on all the physical disks in the RAID Set. Thus each Volume Set on the RAID Set will have its data spread evenly across all the disks in the RAID Set. Volume Sets of different RAID levels may coexist on the same RAID Set.

In the illustration below, Volume 1 can be assigned a RAID 5 level of operation while Volume 0 might be assigned a RAID 0+1 level of operation.

---

## RAID Set 1 (3 Individual Disks)

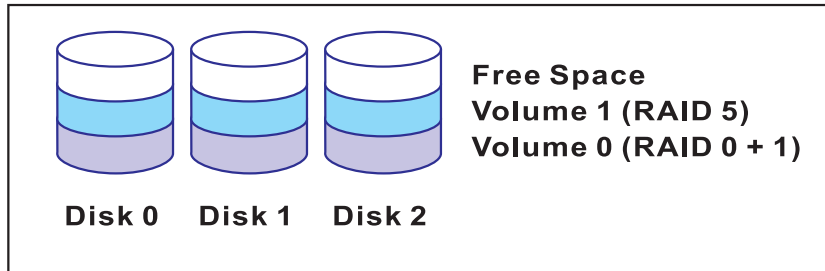

### 1.3.3 Easy of Use features

#### 1.3.3.1 Instant Availability/Background Initialization

RAID 0 and RAID 1 volume set can be used immediately after the creation. But the RAID 3, 5 and 6 volume sets must be initialized to generate the parity. In the Normal Initialization, the initialization proceeds as a background task, the volume set is fully accessible for system reads and writes. The operating system can instantly access to the newly created arrays without requiring a reboot and waiting the initialization complete. Furthermore, the RAID volume set is also protected against a single disk failure while initialing. In Fast Initialization, the initialization proceeds must be completed before the volume set ready for system accesses.

#### 1.3.3.2 Array Roaming

The RAID subsystem stores configuration information both in NVRAM and on the disk drives. It can protect the configuration settings in the case of a disk drive or controller failure. Array roaming allows the administrators the ability to move a completely raid set to another system without losing RAID configuration and data on that raid set. If a server fails to work, the raid set disk drives can be moved to another server and inserted in any order.

---

### 1.3.3.3 Online Capacity Expansion

Online Capacity Expansion makes it possible to add one or more physical drive to a volume set, while the server is in operation, eliminating the need to store and restore after reconfiguring the raid set. When disks are added to a raid set, unused capacity is added to the end of the raid set. Data on the existing volume sets residing on that raid set is redistributed evenly across all the disks. A contiguous block of unused capacity is made available on the raid set. The unused capacity can create additional volume set. The expansion process is illustrated as following figure.

#### Before Array Expansion

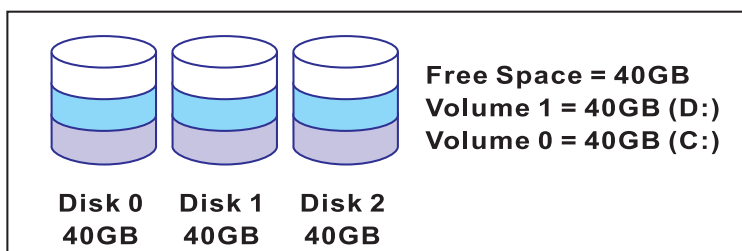

#### Array - A 120GB

The RAID subsystem controller redistributes the original volume set over the original and newly added disks, using the same fault-tolerance configuration. The unused capacity on the expand raid set can then be used to create an additional volume sets, with a different fault tolerance setting if user need to change.

#### After Array Expansion (Adding One Disk)

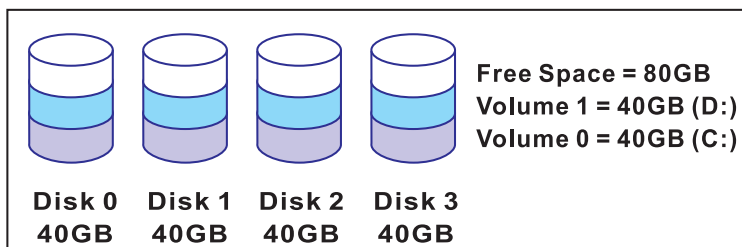

#### Array - A 160GB

---

### **1.3.3.4 Online RAID Level and Stripe Size Migration**

User can migrate both the RAID level and stripe size of an existing volume set, while the server is online and the volume set is in use. Online RAID level/stripe size migration can prove helpful during performance tuning activities as well as in the event that additional physical disks are added to the RAID subsystem. For example, in a system using two drives in RAID level 1, you could add capacity and retain fault tolerance by adding one drive. With the addition of third disk, you have the option of adding this disk to your existing RAID logical drive and migrating from RAID level 1 to 5. The result would be parity fault tolerance and double the available capacity without taking the system off.

### **1.3.4 High availability**

#### **1.3.4.1 Creating Hot Spares**

A hot spare drive is an unused online available drive, which is ready for replacing the failure disk drive. In a RAID level 1, 0+1, 3, 5 or 6 raid set, any unused online available drive installed but not belonging to a raid set can define as a hot spare drive. Hot spares permit you to replace failed drives without powering down the system. When RAID subsystem detects a UDMA drive failure, the system will automatic and transparent rebuilds using hot spare drives. The raid set will be reconfigured and rebuilt in the background, while the RAID subsystem continues to handle system request. During the automatic rebuild process, system activity will continue as normal, however, the system performance and fault tolerance will be affected.

**Important:**



The hot spare must have at least the same or more capacity as the drive it replaces.

---

#### ***1.3.4.2 Hot-Swap Disk Drive Support***

The RAID subsystem has built the protection circuit to support the replacement of UDMA hard disk drives without having to shut down or reboot the system. The removable hard drive tray can deliver “hot swappable,” fault-tolerant RAID solutions at prices much less than the cost of conventional SCSI hard disk RAID subsystems. We provide this feature for subsystems to provide the advanced fault tolerant RAID protection and “online” drive replacement.

#### ***1.3.4.3 Hot-Swap Disk Rebuild***

A Hot-Swap function can be used to rebuild disk drives in arrays with data redundancy such as RAID level 1(0+1), 3, 5 and 6. If a hot spare is not available, the failed disk drive must be replaced with a new disk drive so that the data on the failed drive can be rebuilt. If a hot spare is available, the rebuild starts automatically when a drive fails. The RAID subsystem automatically and transparently rebuilds failed drives in the background with user-definable rebuild rates. The RAID subsystem will automatically restart the system and the rebuild if the system is shut down or powered off abnormally during a reconstruction procedure condition. When a disk is Hot Swap, although the system is functionally operational, the system may no longer be fault tolerant. Fault tolerance will be lost until the removed drive is replaced and the rebuild operation is completed.

---

## **Chapter 2**

# **Installation Overview**

Getting started with the NAS subsystem consists of the following steps:

- ❖ Unpack the storage subsystem.
- ❖ Identifying Parts of the subsystem.
- ❖ Connect the NAS subsystem to the network.
- ❖ Power on the subsystem.
- ❖ Install Hard Drives.

### ***2.1 Unpacking the Subsystem***

Before we continue, you need to unpack the subsystem and verify that the contents of the shipping carton are all there and in good condition. Before removing the subsystem from the shipping carton, you should visually inspect the physical condition of the shipping carton. Exterior damage to the shipping carton may indicate that the contents of the carton are damaged. If any damage is found, do not remove the components; contact the dealer where you purchased the subsystem for further instructions.

The package contains the following items:

- SN-3163 NAS subsystem unit
- Three power cords
- One external SCSI cable
- Two CAT.5 Ethernet LAN cables
- One external null modem cable

- 
- One external UPS cable
  - Installation Reference Guide
  - Spare screws, etc.

If any of these items are missing or damaged, please contact your dealer or sales representative for assistance.



---

## 2.2 Identifying Parts of the subsystem

The illustrations below identify the various features of the subsystem. Get yourself familiar with these terms as it will help you when you read further in the following sections.

### 2.2.1 Front View

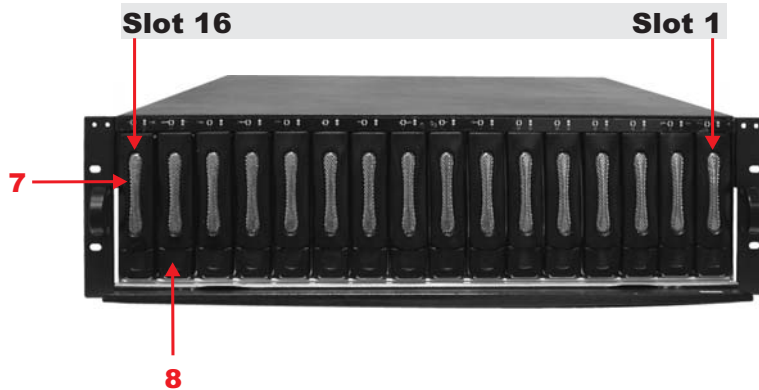
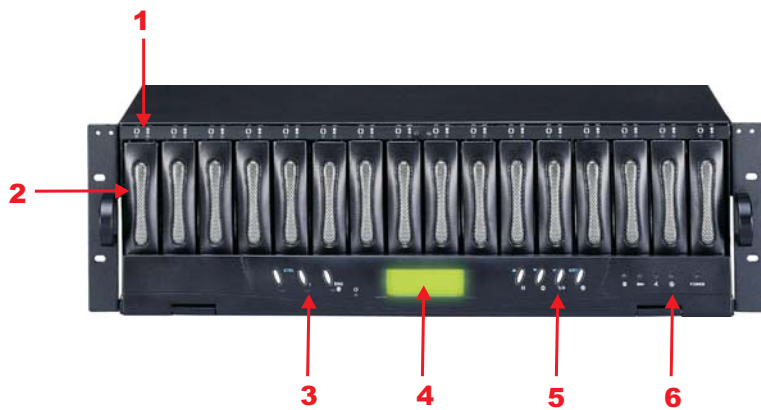

## 1. HDD status Indicator



Parts	Function
HDD Status LEDs ● ✕	Green LED indicates power is on and hard drive status is good for this slot. If there is no hard drive, the LED is red. If hard drive detected in this slot or the hard drive is failure, the LED is orange.
HDD access LEDs ↻	These LED will blink blue when the hard drive is being accessed.

## 2. HDD trays 1 ~ 16 (From right to left)

### 3. Smart Function Panel - Function Keys

Parts	Function
Access LED (↻)	Blue blinking LED indicates data is being accessed.

## 4. LCD display panel





### 5. Smart Function Panel - Function Keys for RAID configuration

The smart LCD panel is where you will configure the RAID subsystem. If you are configuring the subsystem using the LCD panel, please press the controller button to configure your RAID subsystem.

Parts	Function
Up and Down arrow buttons ▲ ▼	Use the Up or Down arrow keys to go through the information on the LCD screen. This is also used to move between each menu when you configure the subsystem.
Select button ▼	This is used to enter the option you have selected.
Exit button EXIT	Press this button to return to the previous menu.

---

## 6. Environment status

Parts	Function
Voltage warning LED 	An alarm will sound warning of a voltage abnormality and this LED will turn red.
Over temp LED 	If temperature irregularity in these systems occurs (HDD slot temperature over 55°C), this LED will turn red and an alarm will sound.
Fan fail LED 	When a fan's rotation speed is lower than 2600rpm, this LED will turn red and an alarm will sound.
Power fail LED 	If a redundant power supply fails, this LED will turn red and an alarm will sound.
Power LED	Green LED indicates power is on.

## 7. Tray Lever

## 8. Tray Latch

---

## 2.2.2 Rear View

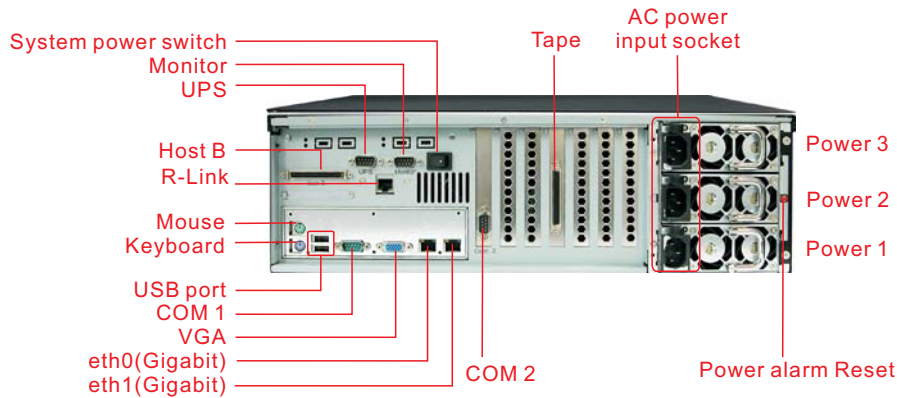

### 1. Power Supply Alarm Reset button

You can push the power supply reset button to stop the power supply buzzer alarm.

### 2. Monitor Port

The subsystem is equipped with a serial monitor port allowing you to connect a PC or terminal.

### 3. Uninterrupted Power Supply (UPS) Port

The subsystem may come with an optional UPS port allowing you to connect a UPS (dump mode UPS) device. Connect the cable from the UPS device to the UPS port located at the rear of the subsystem. This will automatically allow the subsystem to use the functions and features of the UPS.

### 4. Host Channel B

Connect to Host's SCSI adapter or other devices.

---

## **5. R-Link Port : Remote Link through RJ-45 ethernet for remote management**

The subsystem is equipped with one 10/100 Ethernet RJ45 LAN port. You use web-based browser to management RAID subsystem through Ethernet for remote configuration and monitoring.

Link LED: Green LED indicates ethernet is linking.

Access LED: The LED will blink orange when the 100Mbps ethernet is being accessed.

## **6. Power Supply Unit 1 ~ 3**

Three power supplies (power supply 1, power supply 2 and power supply 3) are located at the rear of the subsystem. Turn on the power of these power supplies to power-on the subsystem. The “power” LED at the front panel will turn green.

If a power supply fails to function or a power supply was not turned on, the “” Power fail LED will turn red and an alarm will sound. An error message will also appear on the LCD screen warning of power failure. Press the Power Supply Alarm Reset button at the rear to stop the alarm.

---

## 2.3 Connecting NAS subsystem to Your Network

1. Before you use the NAS subsystem, please configuring your NAS subsystem at first. (Refer to Chapter 3 for configuring your RAID subsystem)
2. To connect the NAS unit to the network, insert the cable that came with the unit into the network connection (LAN0) on the back of NAS unit. Insert the other end into a 10/100 BASE-T Ethernet connection on your network hub or switch.

## 2.4 Powering-on the Subsystem

You should press the System Power Supply Switch. It will turn the NAS subsystem on and the Self-Test will be started automatically.

1. Plug in all the power cords or power connectors located at the rear of the subsystem.

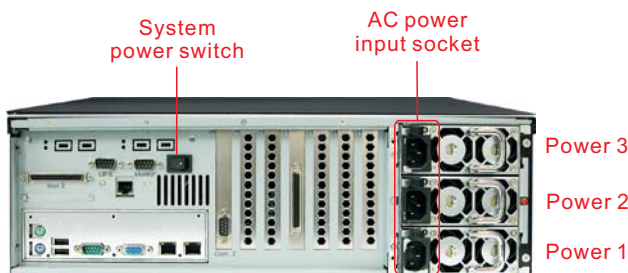

### Note:

The subsystem is equipped with N+1 redundant PFC (power factor correction), Full Range power supplies. The subsystem will automatically selector voltage.

2. You should press the system switch to turn on the power.
3. The “Power” LED on the front panel will turn green.

---

## 2.5 Install Hard Drives

This section describes the physical locations of the hard drives supported by the subsystem and gives instructions on installing a hard drive. The subsystem supports hot-swapping allowing you to install or replace a hard drive while the subsystem is running.

1. Pull out an empty disk tray. (You can install in any available slot.)
2. Take off the bracket before installing hard drive.

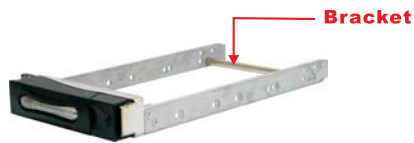

3. Place the hard drive in the disk tray.
4. Install the mounting screws on each side to secure the drive in the mobile rack.

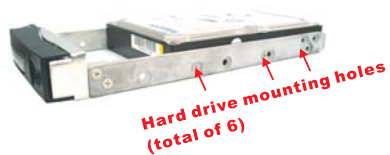

**Note:**

Insert screws through the front sides of the mounting holes.

5. Slide the tray into a slot until it clicks into place. The HDD status LED will turn green on front panel.



6. Press the lever in until you hear the latch click into place.
7. If the HDD power LED did not turn green, check the hard drive is in good condition.
8. If the hard drive is not being accessed, the HDD access LED will not illuminate. The LED blinks only when being accessed.

---

## 2.6 Install OS

### 2.6.1 NAS subsystem with ProNAS DOM

1. ProNAS is DOM (Disk on Module) based NAS operation environment. It makes NAS subsystem operating with zero OS installation procedure.
2. To getting start ProNAS configuration after the first time power on, please reference “ProNAS Configuration Guide”.

### 2.6.2 NAS subsystem with Microsoft WSS

1. Configuring the RAID functions in the NAS subsystem.
2. Connect a keyboard and a VGA monitor to the NAS subsystem.
3. To ensure proper communications between the NAS subsystem and Web browser-based RAID management, Please connect the NAS subsystem Monitor port to COM1 port.

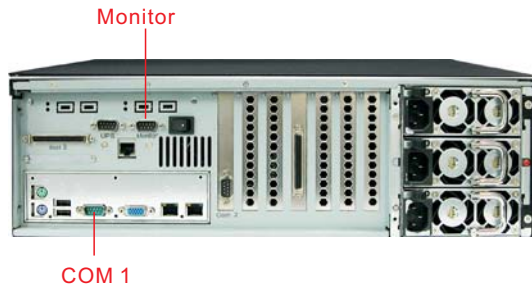

4. Connect a CD-ROM. (Connect a USB port on the CD-ROM to USB port of the NAS subsystem. ) Insert WSS CD.

# Chapter 3

## RAID Configuring

The subsystem has a setup configuration utility built in containing important information about the configuration as well as settings for various optional functions in the subsystem. This chapter explains how to use and make changes to the setup utility.

### ***Configuration Methods***

There are three methods of configuring the subsystem. You may configure through the following methods:

- VT100 terminal connected through the controller's serial port
- Front panel touch-control keypad
- Web browser-based Remote RAID management



#### **Important:**

The subsystem allows you to access the utility using only one method at a time. You cannot use both methods at the same time.

### ***3.1 Configuring through a Terminal***

Configuring through a terminal will allow you to use the same configuration options and functions that are available from the LCD panel. To start-up:

1. Connect a VT100 compatible terminal or a PC operating in an equiva-

---

lent terminal emulation mode to the monitor port located at the rear of the subsystem.

**Note:**

You may connect a terminal while the subsystem's power is on.

2. Power-on the terminal.
3. Run the VT100 program or an equivalent terminal program.

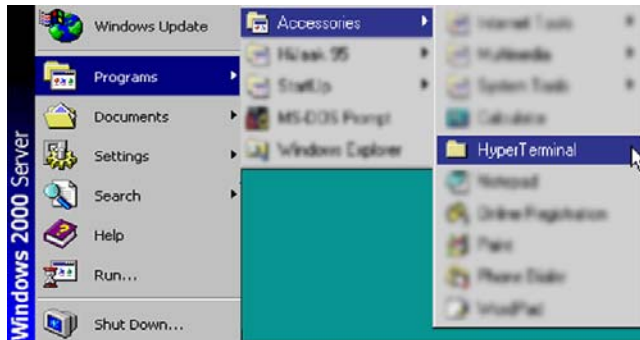



4. The default setting of the monitor port is 115200 baud rate, 8 data bit, non-parity, 1 stop bit and no flow control.

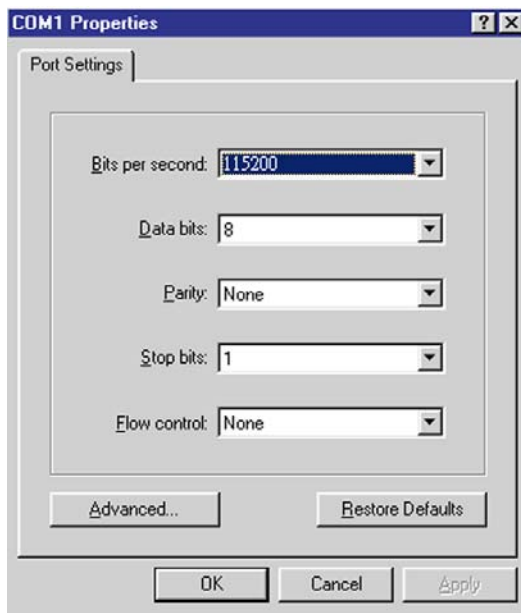

- 
5. Click  disconnect button.

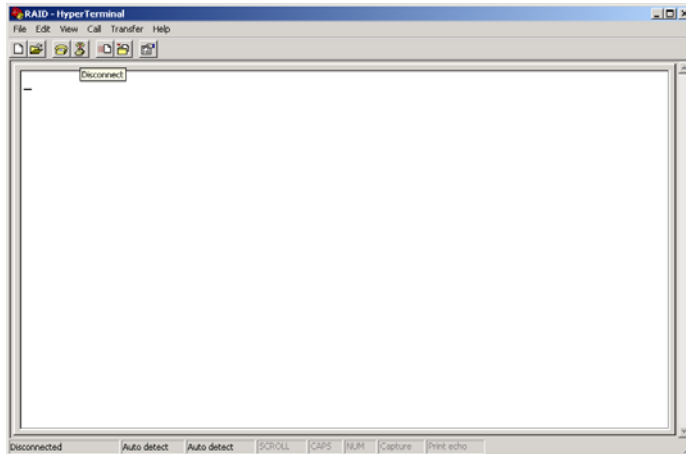

6. Open the File menu, and then open Properties.

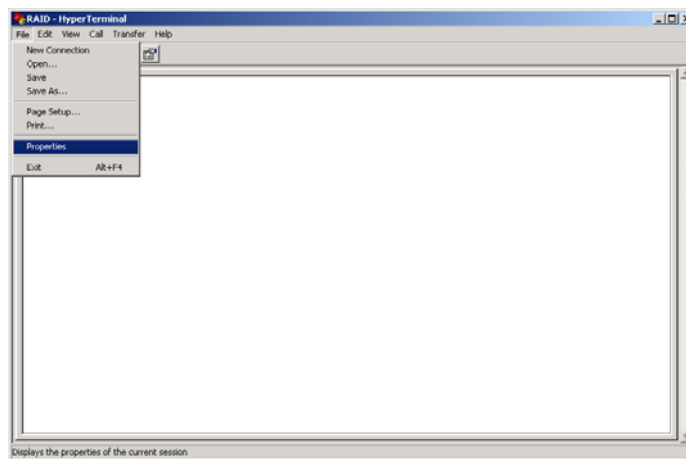

- 
7. Open the Settings Tab.

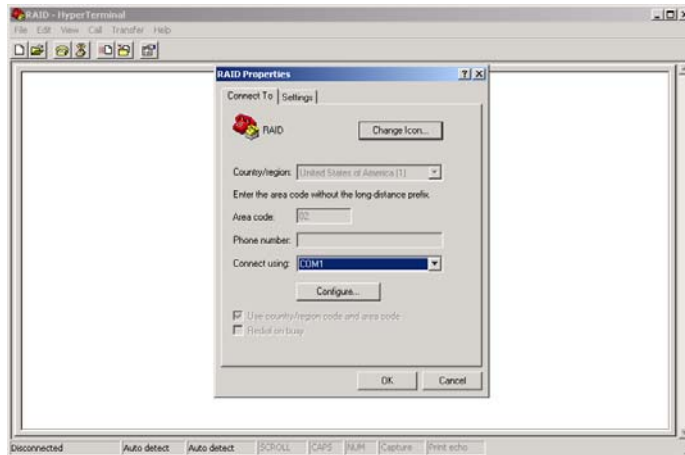

8. Open the Settings Tab. Function, arrow and ctrl keys act as: Terminal Keys, Backspace key sends: Ctrl+H, Emulation: VT100, Telnet terminal: VT100, Back scroll buffer lines: 500. Click OK.

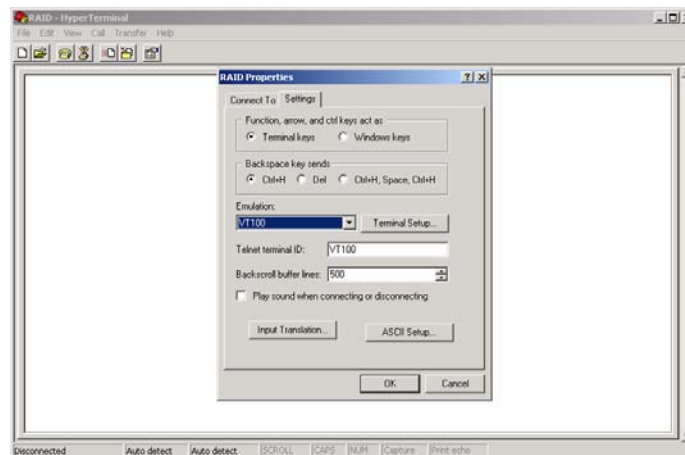

- 
9. Now, the VT100 is ready to use. After you have finished the VT100 Terminal setup, you may press “ X “ key (in your Terminal) to link the RAID subsystem and Terminal together. Press “X’ key to display the disk array Monitor Utility screen on your VT100 Terminal.
  10. The Main Menu will appear.

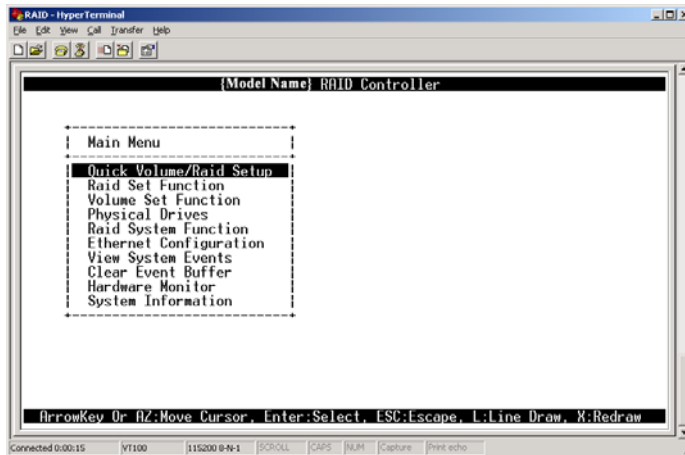

## Keyboard Function Key Definitions

- “ A “ key - to move to the line above
- “ Z “ key - to move to the next line
- “ Enter “ key - Submit selection function
- “ ESC “ key - Return to previous screen
- “ L ” key - Line draw
- “ X ” key - Redraw

---

## Main Menu

The main menu shows all function that enables the customer to execute actions by clicking on the appropriate link.

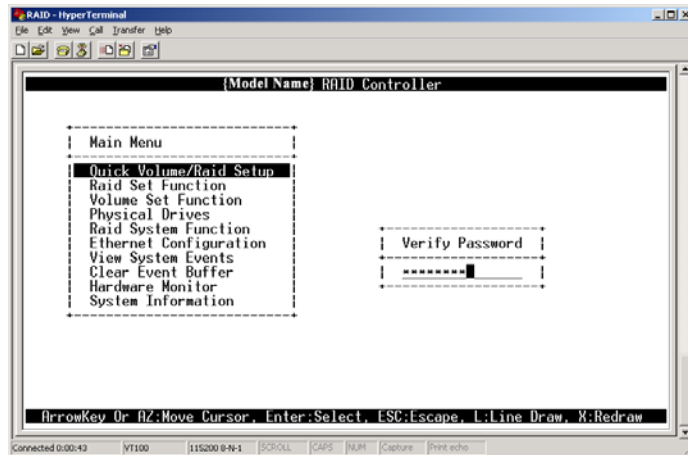

### Note:

The password option allows user to set or clear the raid subsystem's password protection feature. Once the password has been set, the user can only monitor and configure the raid subsystem by providing the correct password. The password is used to protect the internal RAID subsystem from unauthorized entry. The controller will check the password only when entering the Main menu from the initial screen. The RAID subsystem will automatically go back to the initial screen when it does not receive any command in twenty seconds. The RAID subsystem password is default setting at **0000000** by the manufacture.

---

### ***VT100 terminal configuration Utility Main Menu Options***

Select an option and the related information or submenu items display beneath it. The submenus for each item are explained on the section 3.3. The configuration utility main menu options are:

<b>Option</b>	<b>Description</b>
Quick Volume And Raid Set Setup	Create a RAID configurations which is consist of the number of physical disk installed
Raid Set Functions	Create a customized raid set
Volume Set Functions	Create a customized volume set
Physical Drive Functions	View individual disk information
Raid System Functions	Setting the raid system configurations
Ethernet Configuration	Setting the Ethernet configurations
Views System Events	Record all system events in the buffer
Clear Event Buffer	Clear all event buffer information
Hardware Monitor	Show all system environment status
System Information	View the controller information

---



## 3.2 Configuring the Subsystem Using the LCD Panel

The LCD Display front panel function keys are the primary user interface for the Disk Array. Except for the “Firmware update” ,all configuration can be performed through this interface.The LCD provides a system of screens with areas for information, status indication, or menus. The LCD screen displays up to two lines at a time of menu items or other information. The RAID sub-system password is default setting at **00000000** by the manufacture.

### Function Key Definitions

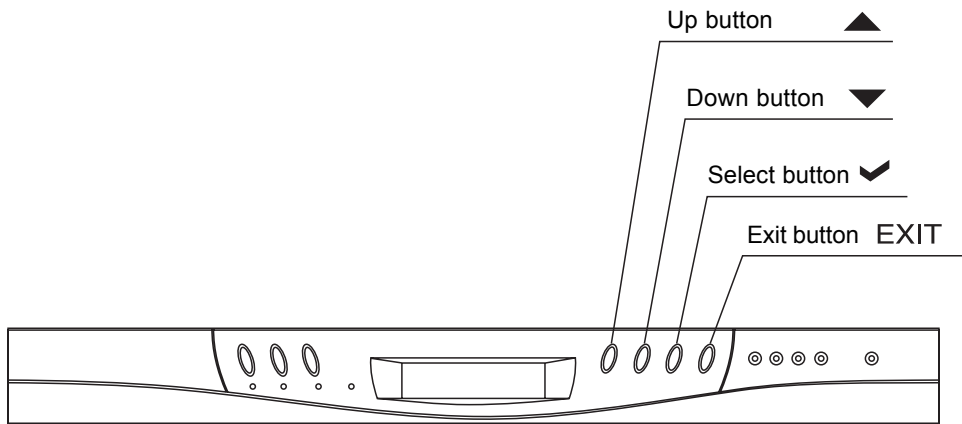
The four function keys at the top of the front panel perform the following functions :



Parts	Function
Up or Down arrow buttons  	Use the Up or Down arrow keys to go through the information on the LCD screen. This is also used to move between each menu when you configure the subsystem.
Select button 	This is used to enter the option you have selected.
Exit button EXIT	Press this button to return to the previous menu.

---

### 3.2.1 Menu Diagram

The following tree diagram is a summary of the various configuration and setting functions that can be accessed through the LCD panel menus or the terminal monitor.

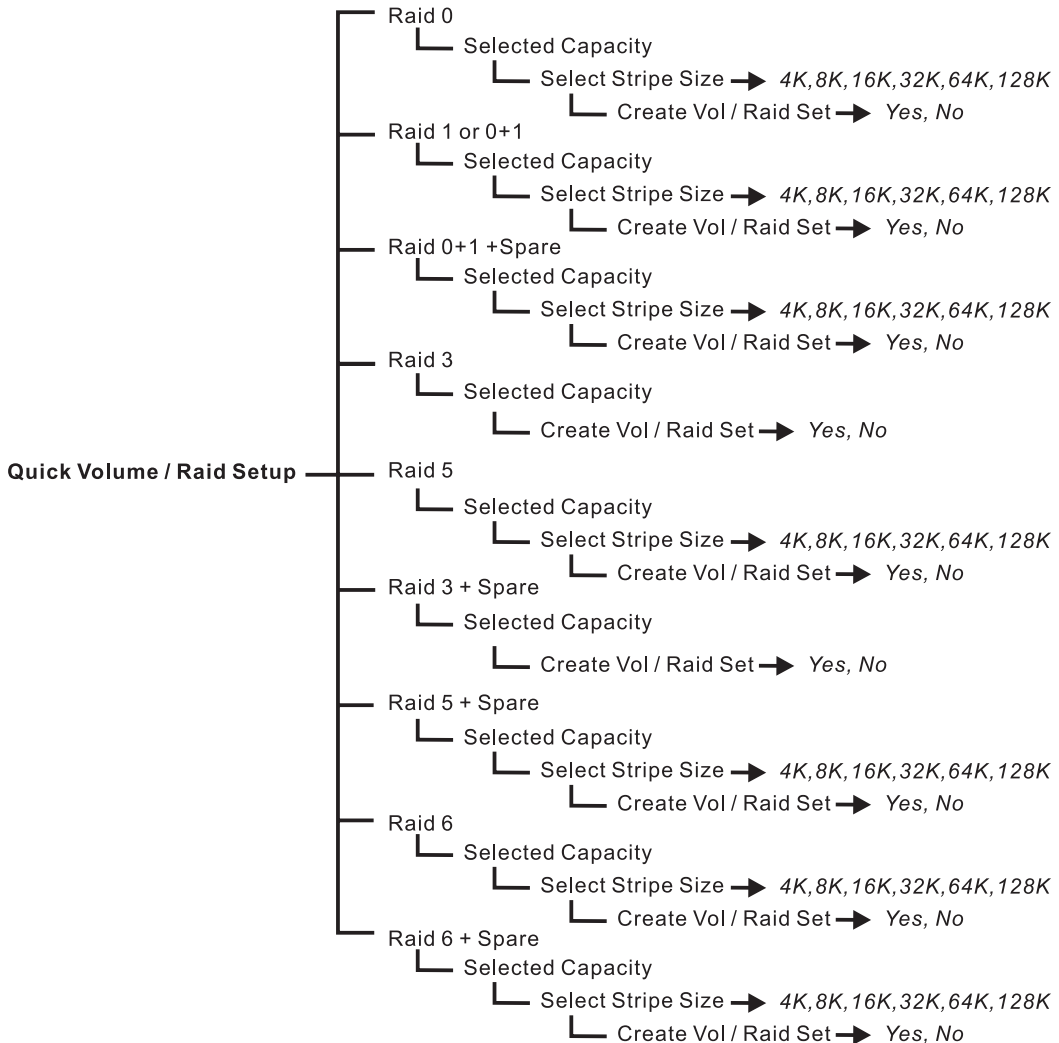

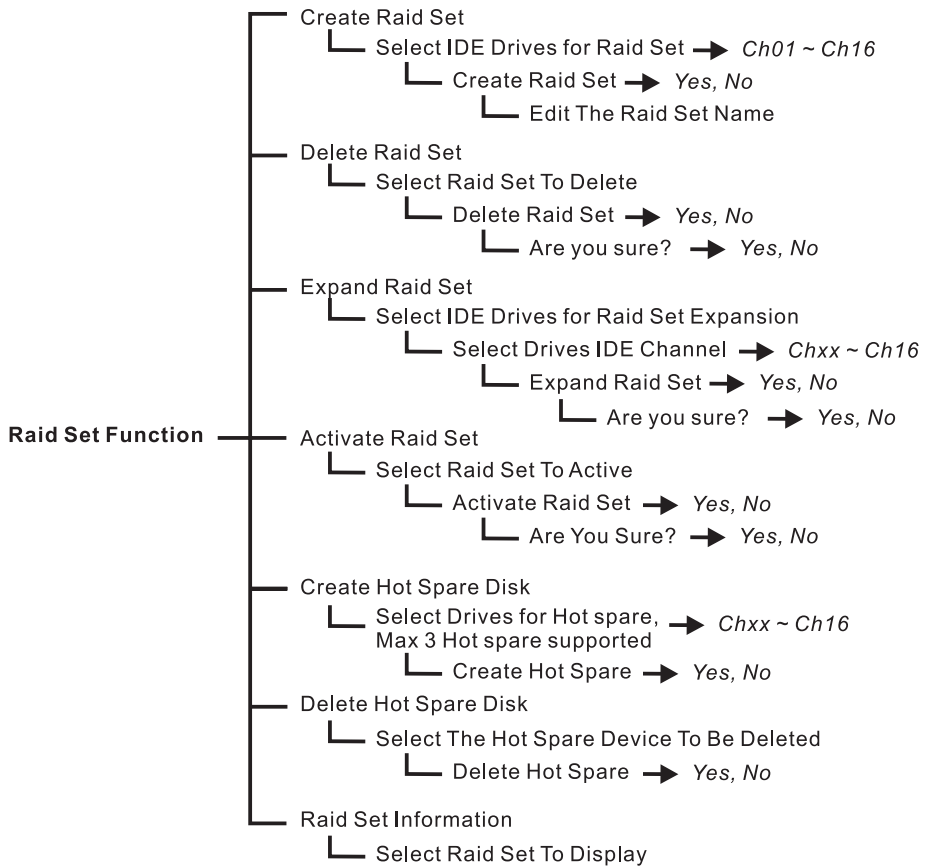



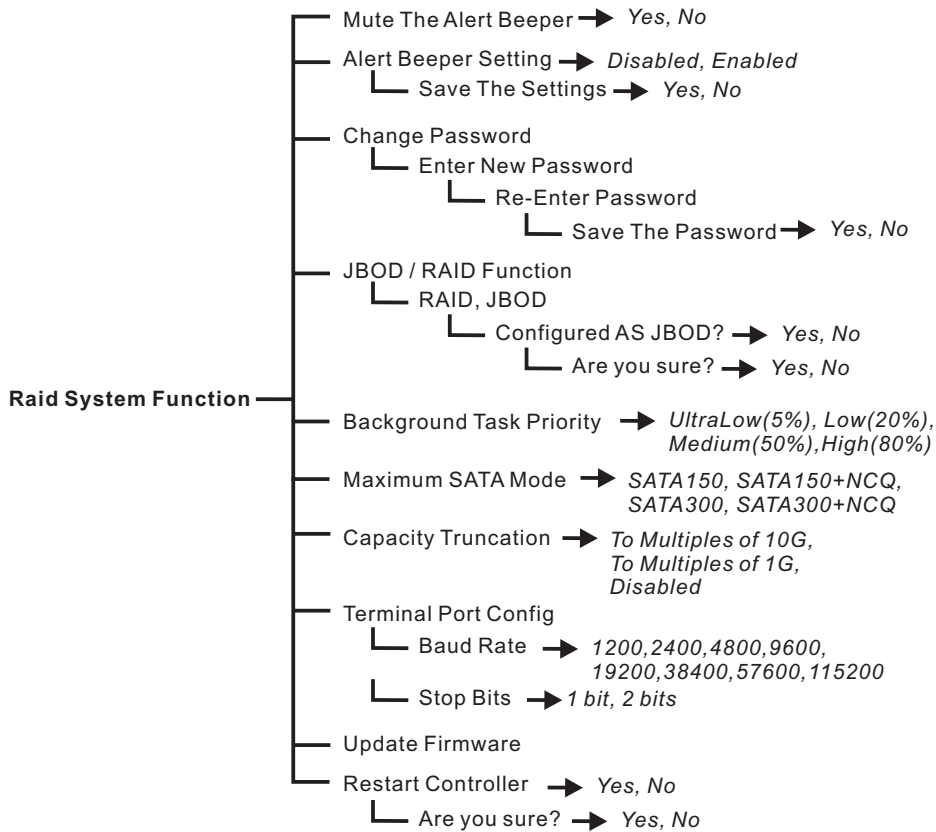
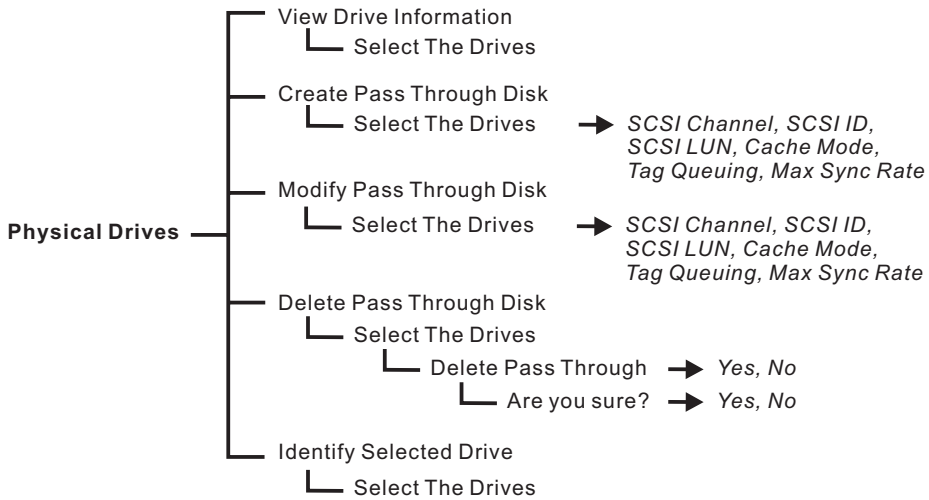

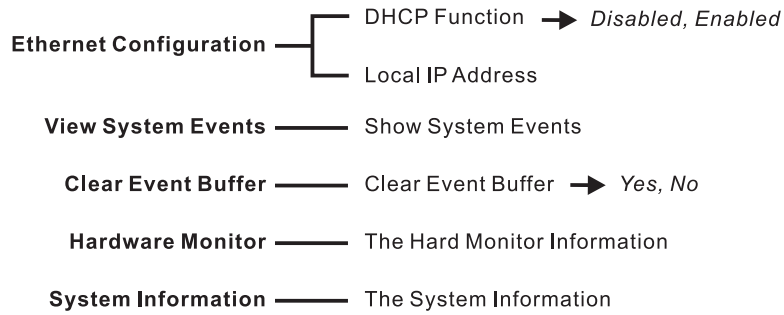

### 3.3 Web browser-based Remote RAID management via R-Link ethernet port

Configuration of the internal RAID subsystem with remote RAID management is a web browser-based application, which utilizes the browser installed on your operating system. Web browser-based remote RAID management can be used to manage all the raid function.

To configure internal RAID subsystem on a remote machine, you need to know its IP Address. Launch your web browser by entering `http://[IP Address]` in the remote web browser.



#### Important:

The Ethernet default IP is “192.168.001.100”. DHCP function is “enable”. You can configure correct IP Address through the LCD panel or the terminal “Ethernet Configuration” menu.

Note that you must be logged in as administrator with local admin rights on the remote machine to remotely configure it. The RAID subsystem controller default User Name is “admin” and the Password is “00000000”.

Raid Set	IDE Channels	Volume Set(Ch/Id/Lun)	Volume State	Capacity
Raid Set # 00	Ch01	Volume Set # 01 (0/0/1)	Initializing(20.9%)	2.0GB
	Ch02			
	Ch03			
	Ch05			
	Ch08			
Raid Set # 01	Ch11	ST320420A (0/0/0)	Normal	20.4GB

Channel	Usage	Capacity	Model
Ch01	Raid Set # 00	15.4GB	IBM-DTLA-307015
Ch02	N.A.	N.A.	N.A.
Ch03	Raid Set # 00	20.4GB	ST320420A
Ch04	N.A.	N.A.	N.A.
Ch05	Raid Set # 00	20.4GB	ST320420A
Ch06	N.A.	N.A.	N.A.
Ch07	N.A.	N.A.	N.A.
Ch08	Raid Set # 00	15.4GB	IBM-DTLA-307015
Ch09	N.A.	N.A.	N.A.
Ch10	N.A.	N.A.	N.A.

---

### 3.4 Configuring through Web browser-based RAID management

Web browser-based remote RAID management can be used to manage all the raid function.

To configure RAID subsystem on a remote machine, you need to know its IP Address. Launch your web browser by entering `http://[IP Address]` in the remote web browser.



#### Important:

To ensure proper communications between the NAS subsystem and Web browser-based RAID management, Please connect the NAS subsystem Monitor port to COM1 port .

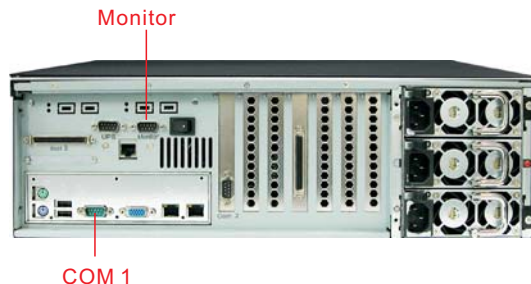

Before you use Web browser-based RAID management tool, please make sure your network is connected without problem, so the first task of RAID configuration is to setup your network.

- 
1. Start web browser. Type ' http://[IP Address] ' and click “” button to enter RAID Configuration page.

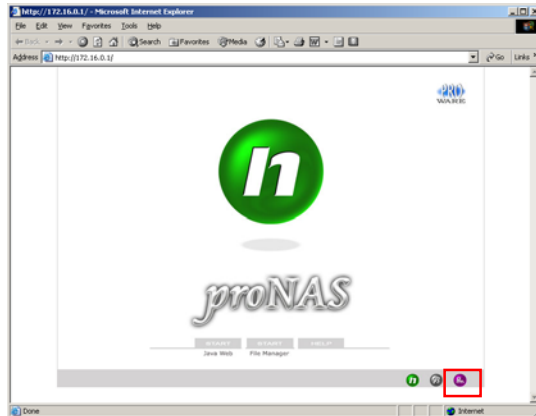

2. Click “ START ” button to enter RAID Configuration page.

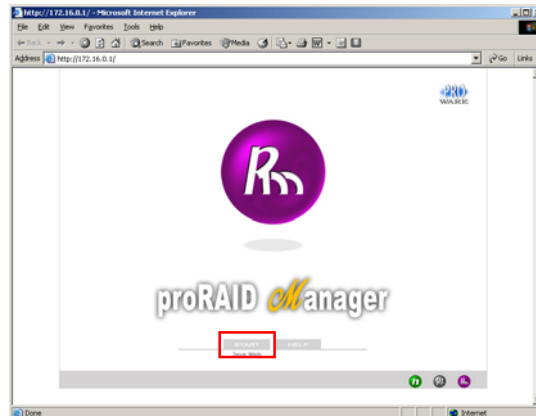

---

## **Main Menu**

The main menu shows all function that enables the customer to execute actions by clicking on the appropriate link.

<b>Individual Category</b>	<b>Description</b>
Quick Create	Create a RAID configuration, which is consist of the number of physical disk installed; it can modify the volume set Capacity, Raid Level, and Stripe Size.
Raid Set Functions	Create a customized raid set.
Volume Set Functions	Create customized volume sets and modify the existed volume sets parameter.
Physical Drive	Create pass through disks and modify the existed pass through drives parameter. It also provides the function to identify the respect disk drive.
System Control	Setting the raid system configurations
Information	View the controller and hardware monitor information. The Raid Set Hierarchy can also view through the RaidSet Hierarchy item.

---

## Configuration Procedures

Below are a few practical examples of concrete configuration procedures.

### 3.5 Quick Create

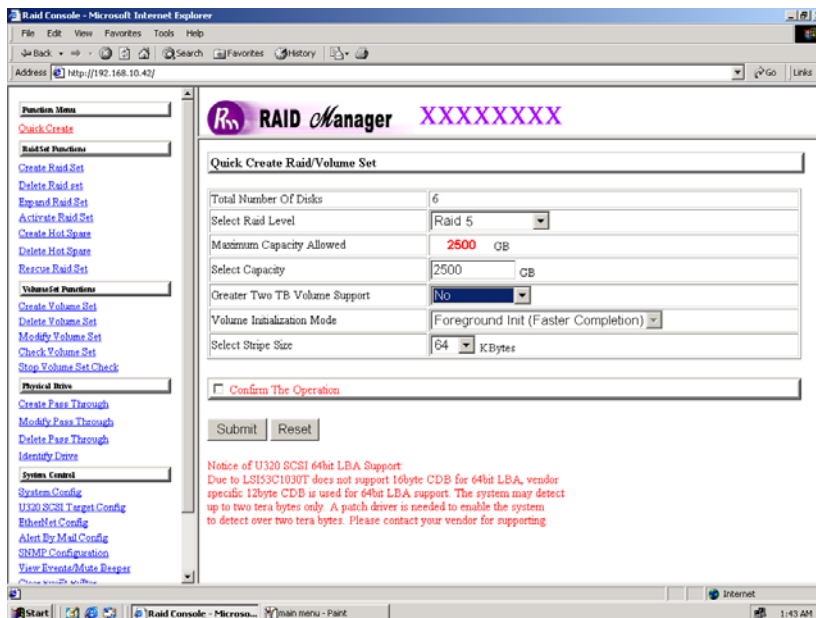

The number of physical drives in the raid subsystem determines the RAID levels that can be implemented with the raid set. You can create a raid set associated with exactly one volume set. The user can change the raid level, capacity, Volume Set Initialization Mode and stripe size . A hot spare option is also created depending upon the existing configuration.

If volume size over 2TB, it will be provided one option “Creater TwoTB Volume Support” Automatically as above menu. There are three model for option “No” , “64bit LBA” , “For Windows”.

---

### **Greater Two TB Volume Support:**

No: still keep the volume size with max. 2TB limitation.

64bit LBA: the max. size 512TB, for Unix or Linux.

Due to LSI53C1030T does not support 16byte CDB for 64bit LBA, vendor specific 12byte CDB is used for 64bit LBA support. The system may detect up to two tera bytes only. A patch driver is needed to enable the system to detect over two tera bytes. Please contact your vendor for supporting.

For Windows: the max. size 16TB , just use with “ basic disk manager “ under OS Window 2000, 2003 or XP. Noted that can't be used by with dynamic disk manager.

Tick on the **Confirm The Operation** and click on the **Submit** button in the Quick Create screen, the raid set and volume set will start to initialize.

Note: In Quick Create your volume set is automatically configured based on the number of disks in your system. Use the Raid Set Function and Volume Set Function if you prefer to customize your system.

---

## 3.6 Raid Set Functions

Use the Raid Set Function and Volume Set Function if you prefer to customize your system. User manual configuration can full control of the raid set setting, but it will take longer to complete than the Quick Volume/Raid Setup configuration. Select the Raid Set Function to manually configure the raid set for the first time or deletes existing raid set and reconfigures the raid set. A raid set is a group of disks containing one or more volume sets.

### 3.6.1 Create Raid Set

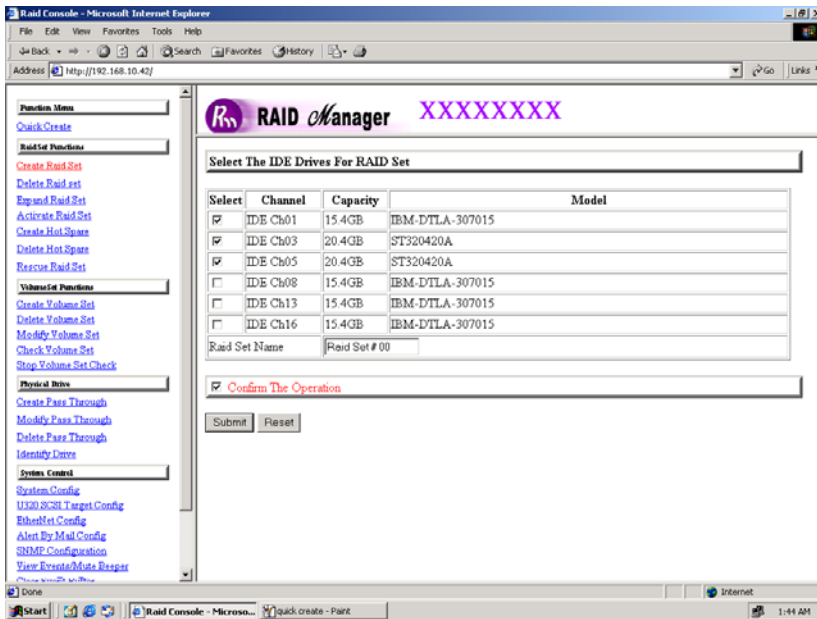

To create a raid set, click on the **Create Raid Set** link. A “*Select The IDE Drive For RAID Set*” screen is displayed showing the IDE drive connected to the current controller. Click on the selected physical drives with the current raid set. Enter 1 to 15 alphanumeric characters to define a unique identifier for a raid set. The default raid set name will always appear as Raid Set. #.

Tick on the **Confirm The Operation** and click on the **Submit** button in the screen, the raid set will start to initialize.

---

### 3.6.2 Delete Raid Set

To delete a raid set, click on the **Delete Raid Set** link. A “*Select The RAID SET To Delete*” screen is displayed showing all raid set existing in the current controller. Click the raid set number you which to delete in the select column to delete screen.

Tick on the **Confirm The Operation** and click on the **Submit** button in the screen to delete it.

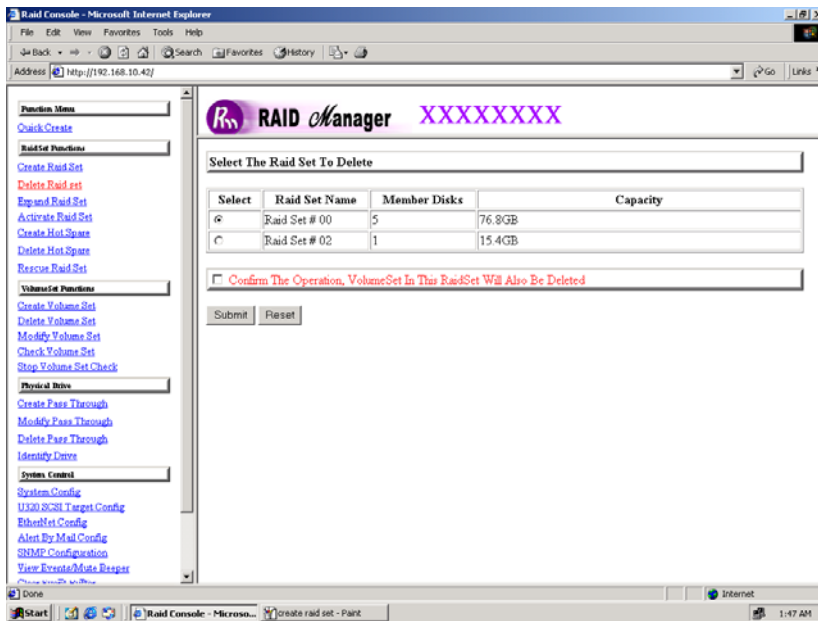

---

### 3.6.3 Expand Raid Set

Use this option to expand a raid set, when a disk is added to your system. This function is active when at least one drive is available.

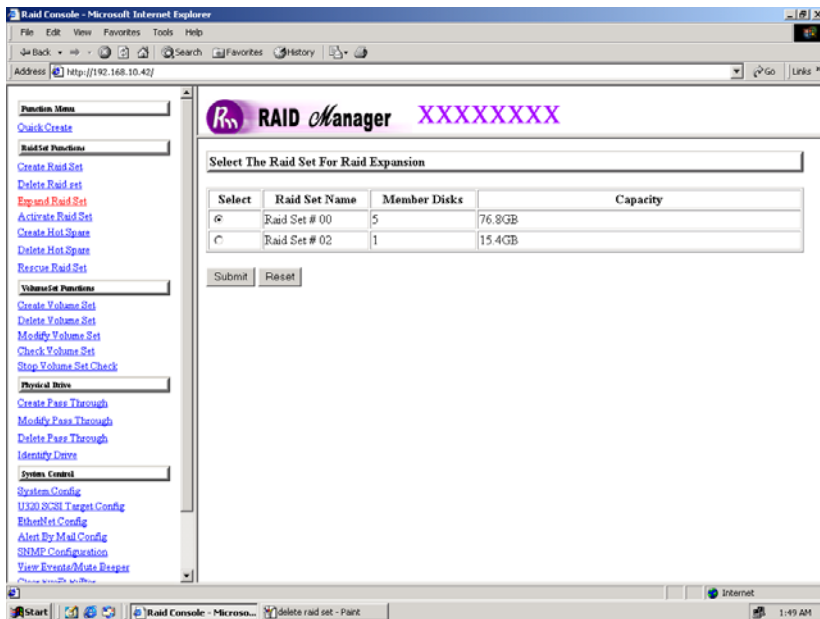

To expand a raid set, click on the **Expand Raid Set** link. Select the target raid set, which you want to expand it.

Tick on the available disk and **Confirm The Operation**, and then click on the **Submit** button in the screen to add disks to the raid set.



#### Note:

1. Once the Expand Raid Set process has started, user cannot stop it. The process must be completed.
2. If a disk drive fails during raid set expansion and a hot spare is available, an auto rebuild operation will occur after the raid set expansion completes.

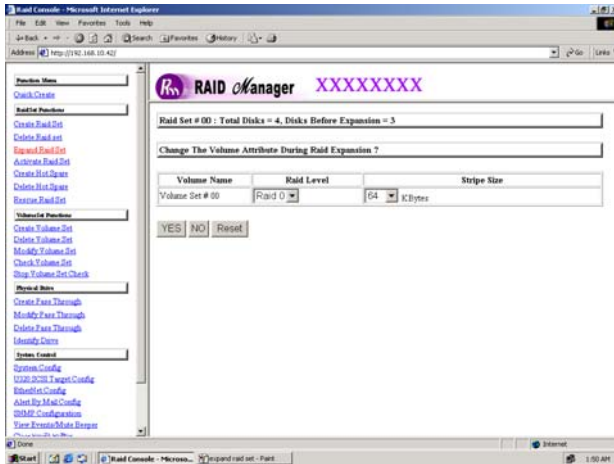
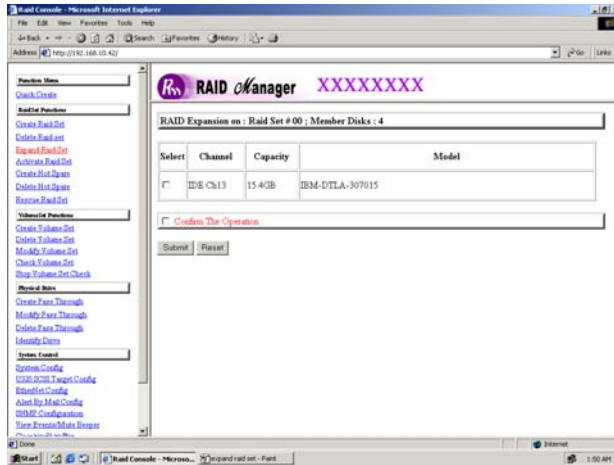

Migrating occurs when a disk is added to a raid set. Migration status is displayed in the raid status area of the Raid Set information when a disk is added to a raid set. Migrating status is also displayed in the associated volume status area of the volume set Information when a disk is added to a raid set.

---

### 3.6.4 Activate Incomplete Raid Set

When one of the disk drive is removed in power off state, the raid set state will change to Incomplete State. If user wants to continue to work, when the RAID subsystem is power on. User can use the Activate Raid Set option to active the raid set. After user complete the function, the Raid State will change to Degraded Mode.

To activate the incomplete the raid set, click on the **Activate Raid Set** link. A “*Select The RAID SET To Activate*” screen is displayed showing all raid set existing in the current controller. Click the raid set number you which to activate in the select column.

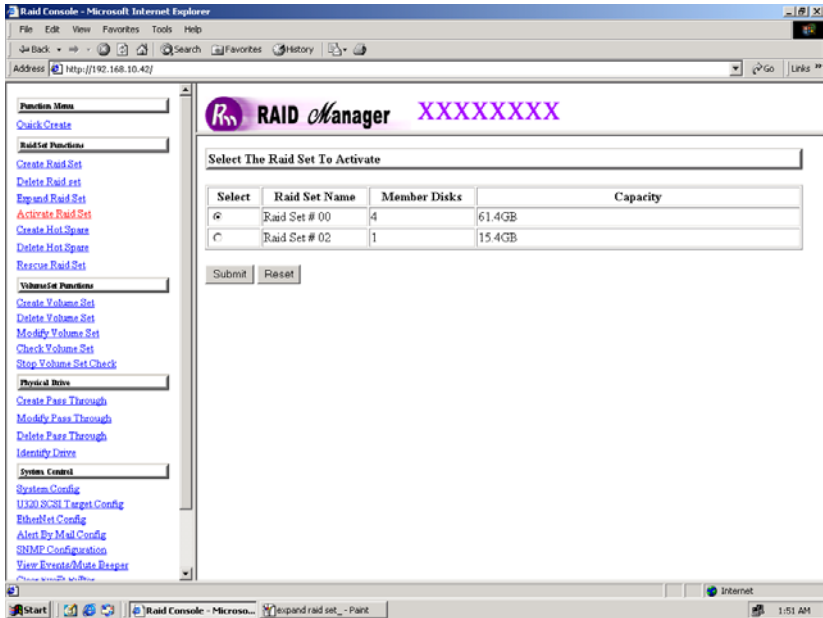

Click on the **Submit** button in the screen to activate the raid set that has removed one of disk drive in the power off state. The RAID subsystem will continue to work in degraded mode.

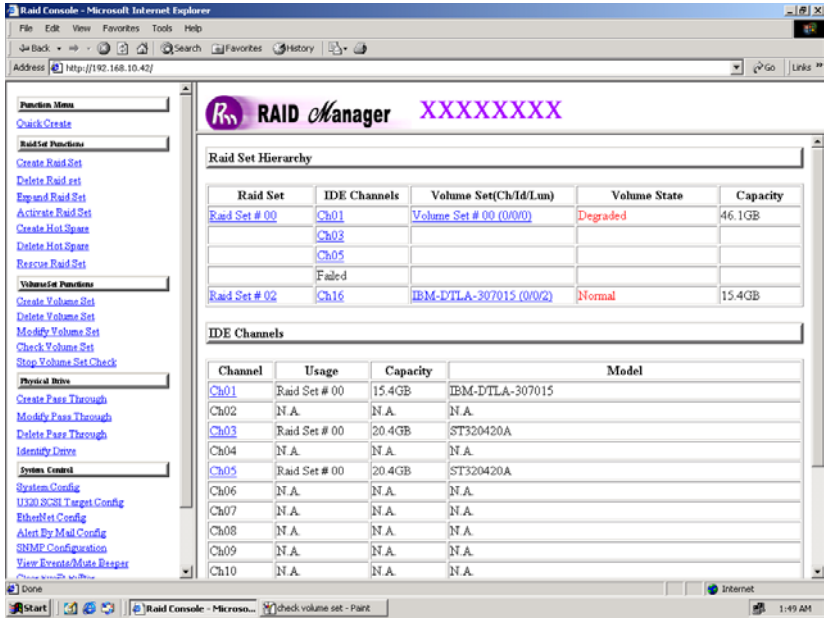

---

### 3.6.5 Create Hot Spare

When you choose the **Create Hot Spare** option in the Raid Set Function, all unused physical devices connected to the current controller appear: Select the target disk by clicking on the appropriate check box. Tick on the **Confirm The Operation**, and click on the **Submit** button in the screen to create the hot spares.

The create Hot Spare option gives you the ability to define a global hot spare.

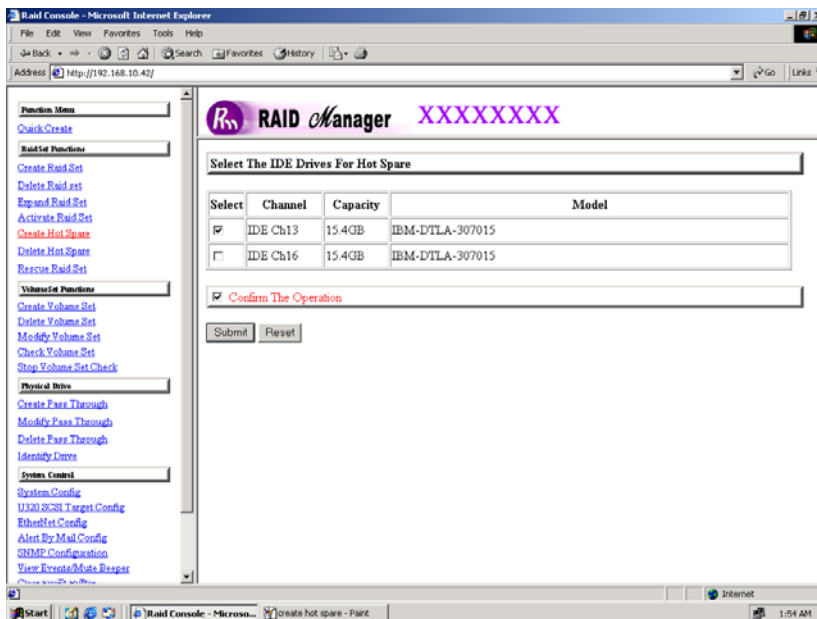

### 3.6.6 Delete Hot Spare

Select the target Hot Spare disk to delete by clicking on the appropriate check box.

Tick on the **Confirm The Operation**, and click on the **Submit** button in the screen to delete the hot spares.

---

### 3.6.7 Rescue Raid Set

If you try to Rescue Missing RAID Set, please contact our engineer for assistance.

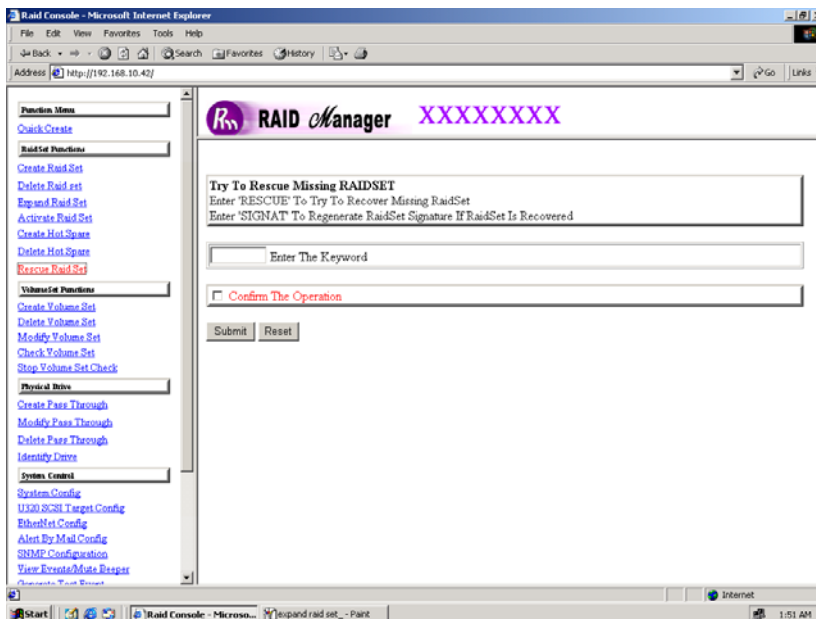

---

## 3.7 Volume Set Function

A volume set is seen by the host system as a single logical device. It is organized in a RAID level with one or more physical disks. RAID level refers to the level of data performance and protection of a volume set. A volume set capacity can consume all or a portion of the disk capacity available in a raid set. Multiple volume sets can exist on a group of disks in a raid set. Additional volume sets created in a specified raid set will reside on all the physical disks in the raid set. Thus each volume set on the raid set will have its data spread evenly across all the disks in the raid set.

### 3.7.1 Create Volume Set

The following is the volume set features:

1. Volume sets of different RAID levels may coexist on the same raid set.
2. Up to 64 volume sets in a raid set can be created by the RAID subsystem controller.

To create volume set from raid set system, move the cursor bar to the main menu and click on the **Create Volume Set** link. The **Select The Raid Set To Create On It** screen will show all raid set number. **Tick** on a raid set number that you want to create and then **click** on the Submit button.

The new create volume set allows user to select the Volume name, capacity, RAID level, strip size, SCSI ID/LUN, Cache mode, tag queuing and Max Sync Rate.

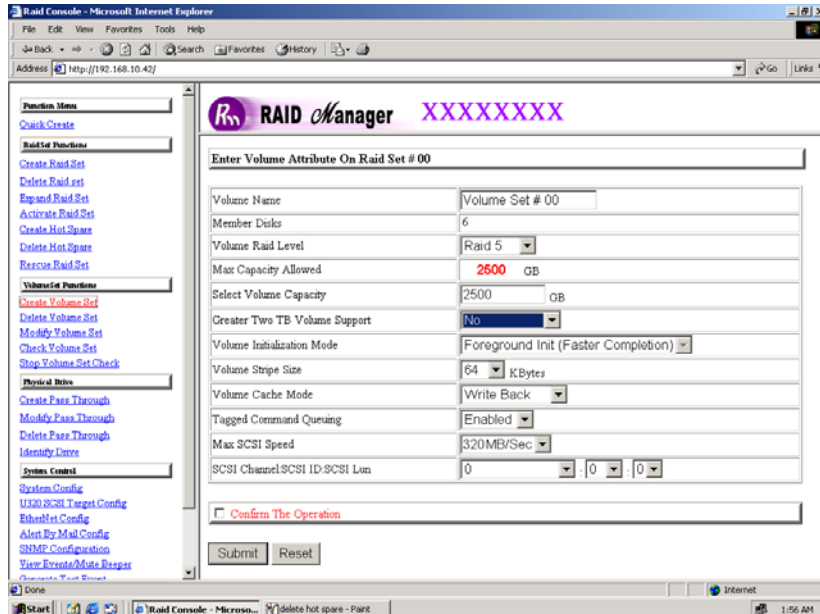

## Volume Name:

The default volume name will always appear as Volume Set. #. You can rename the volume set name providing it does not exceed the 15 characters limit.

## Raid Level:

Set the RAID level for the Volume Set. Highlight *Raid Level* and press **Enter**.

The available RAID levels for the current Volume Set are displayed. Select a RAID level and press **Enter** to confirm.

## Capacity:

The maximum volume size is default in the first setting. Enter the appropriate volume size to fit your application.

**Greater Two TB Volume Support:** If volume size over 2TB, it will be provided one option “Creater TwoTB Volume Support” Automatically.

No: still keep the volume size with max. 2TB limitation.

---

64bit LBA: the max. size 512TB, for Unix or Linux.

Due to LSI53C1030T does not support 16byte CDB for 64bit LBA, vendor specific 12byte CDB is used for 64bit LBA support. The system may detect up to two tera bytes only. A patch driver is needed to enable the system to detect over two tera bytes. Please contact your vendor for supporting.

For Windows: the max. size 16TB , just use with “ basic disk manager “ under OS Window 2000, 2003 or XP. Noted that can't be used by with dynamic disk manager.

**Initialization Mode:**

Set the Initialization Mode for the Volume Set. Foreground mode is faster completion and background is instant available.

**Strip Size:**

This parameter sets the size of the stripe written to each disk in a RAID 0, 1, 0+1, or 5 logical drive. You can set the stripe size to 4 KB, 8 KB, 16 KB, 32 KB, 64 KB, or 128 KB.

A larger stripe size produces better-read performance, especially if your computer does mostly sequential reads. However, if you are sure that your computer does random reads more often, select a small stripe size

Note: RAID level 3 can't modify strip size.

**Cache Mode:**

The RAID subsystem supports Write-Through Cache and Write-Back Cache.

**Tag Queuing:**

The Enabled option is useful for enhancing overall system performance under multi-tasking operating systems. The Command Tag (Drive Channel) function controls the SCSI command tag queuing support for each drive channel. This function should normally remain enabled. Disable this function only when using older SCSI drives that do not support command tag queuing

**Max SCSI Speed:**

The RAID subsystem supports 320 MB/sec as the highest data transfer rate.

**SCSI Channel/SCSI ID/SCSI Lun:**

**SCSI Channel:** The RAID subsystem supports one SCSI Channel or Dual SCSI Channel.

**SCSI ID:** Each SCSI device attached to the SCSI card, as well as the card itself, must be assigned a unique SCSI ID number. A Wide SCSI channel can connect up to 15 devices. The RAID subsystem is as a large SCSI device. We should assign an ID from a list of SCSI IDs.

**SCSI LUN:** Each SCSI ID can support up to 8 LUNs. Most SCSI host adapter treats each LUN like a SCSI disk.

### 3.7.2 Delete Volume Set

To delete Volume from raid set system function, move the cursor bar to the main menu and click on the **Delete Volume Set** link. The **Select The Volume Set To Delete** screen will show all raid set number. **Tick** on a raid set number and the Confirm The Operation and then **click** on the Submit button to show all volume set item in the selected raid set. **Tick** on a volume set number and the Confirm The Operation and then **click** on the **Submit** button to delete the volume set.

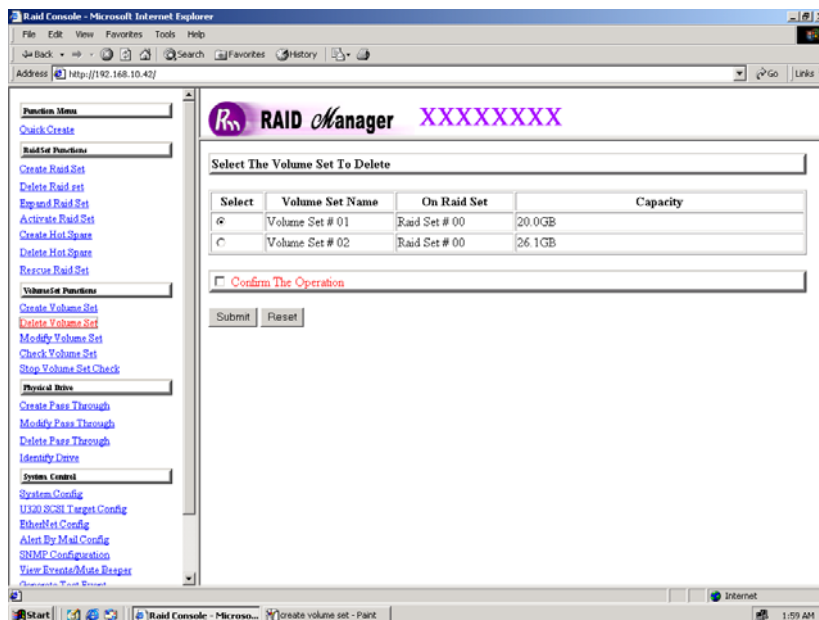

---

### **3.7.3 Modify Volume Set**

To modify a volume set from a raid set:

- (1). Click on the **Modify Volume Set** link.
- (2). Tick on the volume set from the list that you wish to modify. Click on the **Submit** button.

The following screen appears.

Use this option to modify volume set configuration. To modify volume set attribute values from raid set system function, move the cursor bar to the volume set attribute menu and click on it. The modify value screen appears. Move the cursor bar to an attribute item, and then click on the attribute to modify the value. After you complete the modification, tick on the **Confirm The Operation** and click on the **Submit** button to complete the action. User can modify all values except the capacity.

#### **3.7.3.1 Volume Expansion**

Volume Capacity (Logical Volume Concatenation Plus Re-stripe)

Use this raid set expands to expand a raid set, when a disk is added to your system. (refer to section 3.6.3)

The expand capacity can use to enlarge the volume set size or create another volume set. The modify volume set function can support the volume set expansion function. To expand volume set capacity value from raid set system function, move the cursor bar to the volume set **Volume capacity** item and entry the capacity size.

Tick on the **Confirm The Operation** and click on the **Submit** button to complete the action. The volume set start to expand.

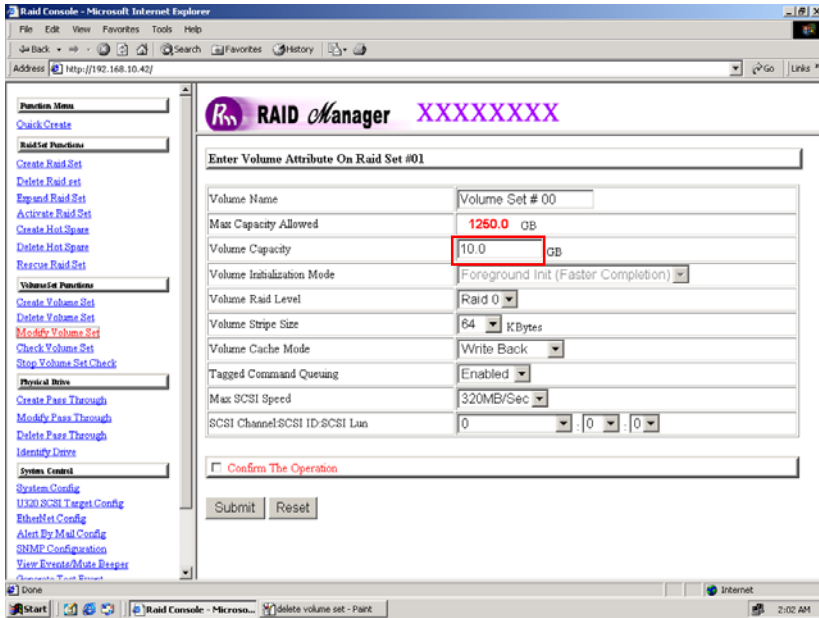

### 3.7.4 Volume Set Migration

Migrating occurs when a volume set is migrating from one RAID level to another, a volume set strip size changes, or when a disk is added to a raid set. Migration status is displayed in the volume status area of the RaidSet Hierarchy screen when one RAID level to another, a Volume set strip size changes or when a disk is added to a raid set.

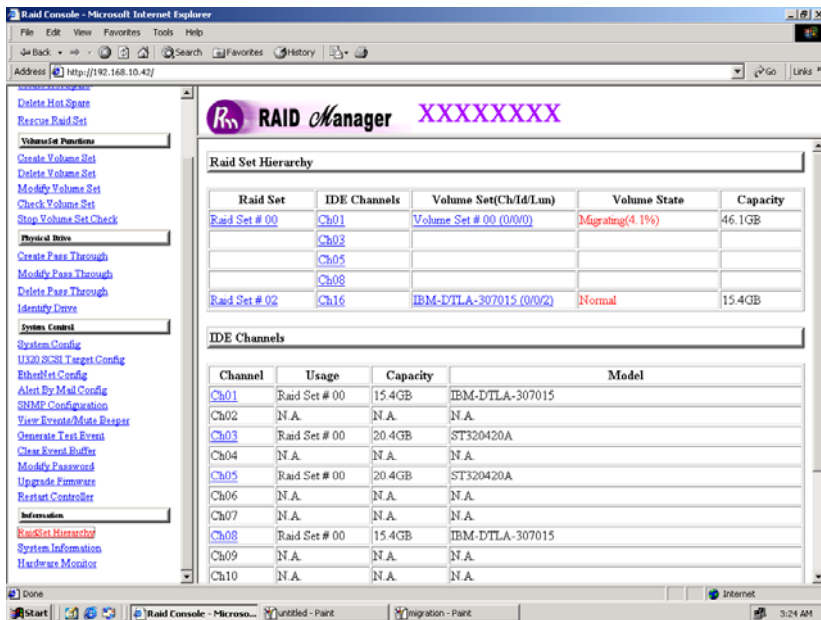

### 3.7.5 Check Volume Set

To check a volume set from a raid set:

- (1). Click on the **Check Volume Set** link.
- (2). **Tick** on the volume set from the list that you wish to check. Tick on Confirm The Operation and click on the **Submit** button.

Use this option to verify the correctness of the redundant data in a volume set. For example, in a system with dedicated parity, volume set check means computing the parity of the data disk drives and comparing the results to the contents of the dedicated parity disk drive. The checking percentage can also be viewed by clicking on RaidSet Hierarchy in the main menu.

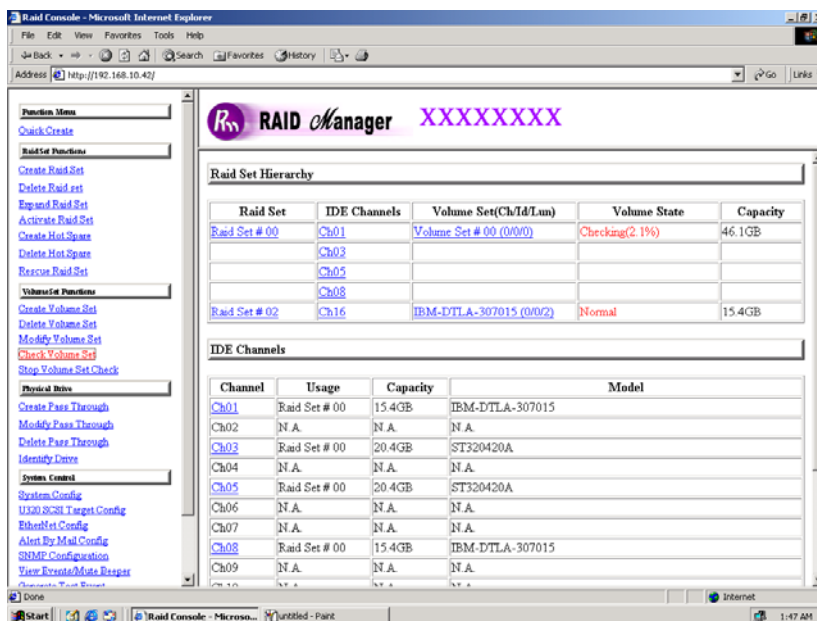

### 3.7.6 Stop VolumeSet Check

Use this option to stop the Check Volume Set function.

---

## 3.8 Physical Drive

Choose this option from the Main Menu to select a physical disk and to perform the operations listed below.

### 3.8.1 Create Pass-Through Disk

To create pass-through disk, move the mouse cursor to the main menu and click on the **Create Pass-Through** link. The relative setting function screen appears.

Disk is no controlled by the internal RAID subsystem firmware and thus cannot be a part of a volume set. The disk is available to the operating system as an individual disk. It is typically used on a system where the operating system is on a disk not controlled by the RAID firmware. User can also select the cache mode, Tagged Command Queuing, Max SCSI speed and SCSI channel/SCSI\_ID/SCSI\_LUN for this volume.

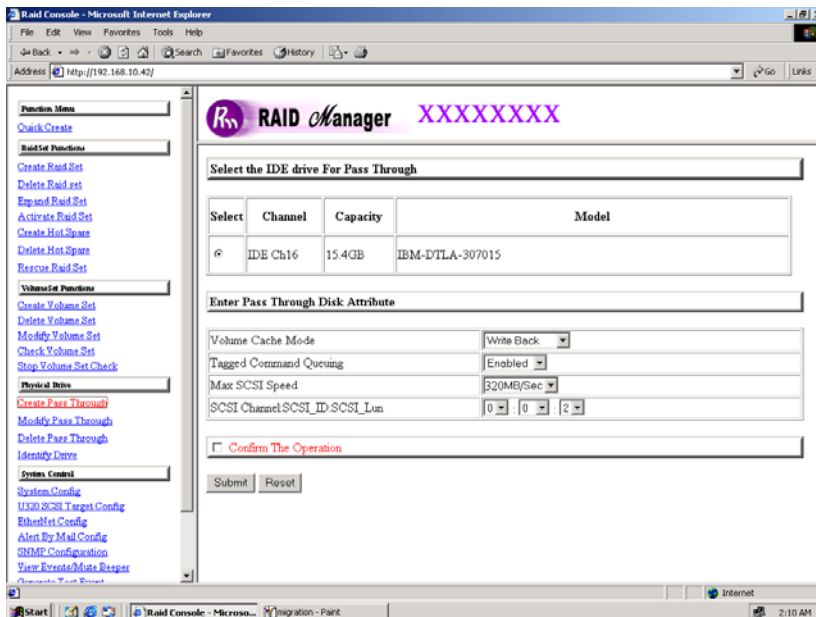

---

### 3.8.2 Modify Pass-Through Disk

Use this option to modify the Pass-Through Disk Attribute. User can modify the cache mode, Tagged Command Queuing, Max SCSI speed and SCSI channel/ID/LUN on an existed pass through disk.

To modify the pass-through drive attribute from the pass-through drive pool, move the mouse cursor bar to click on **Modify Pass-Through** link. The Select The Pass Through Disk For Modification screen appears tick on the Pass-Through Disk from the pass-through drive pool and click on the **Submit** button to select drive.

The Enter Pass-Through Disk Attribute screen appears, modify the drive attribute values, as you want.

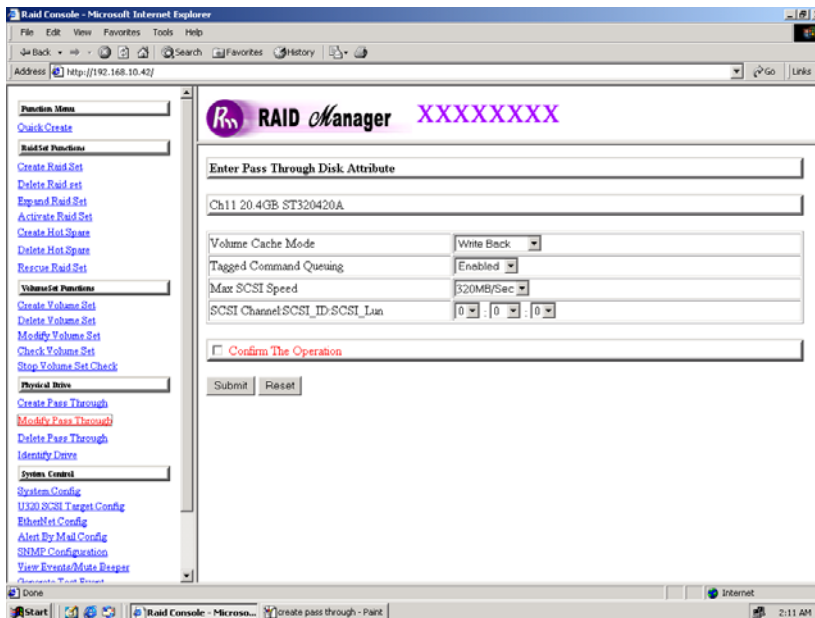

---

### 3.8.3 Delete Pass-Through Disk

To delete pass-through drive from the pass-through drive pool, move the mouse cursor bar to the main menus and click on **Delete Pass Through** link. After you complete the selection, tick on the **Confirm The Operation** and click on the **Submit** button to complete the delete action.

### 3.8.4 Identify Selected Drive

To prevent removing the wrong drive, the selected disk LED will light for physically locating the selected drive when the *Identify Selected Drive* is selected.

To identify the selected drive from the drives pool, move the mouse cursor bar to click on **Identify Selected Drive** link. The Select The IDE Device For identification screen appears tick on the IDE device from the drives pool and Flash method. After completing the selection, click on the **Submit** button to identify selected drive.

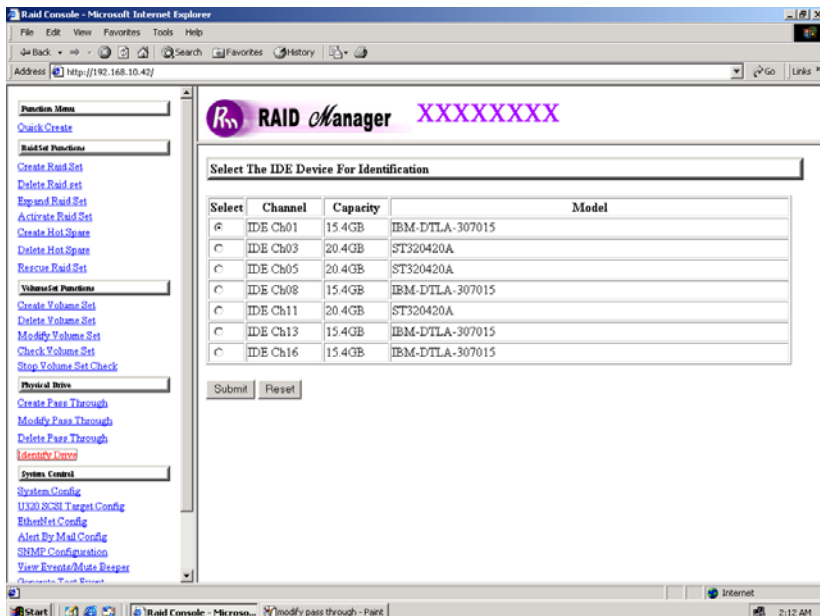

---

## 3.9 System Configuration

### 3.9.1 System Configuration

To set the raid system function, move the cursor bar to the main menu and click on the **Raid System Function** link. The Raid System Function menu will show all items. Select the desired function.

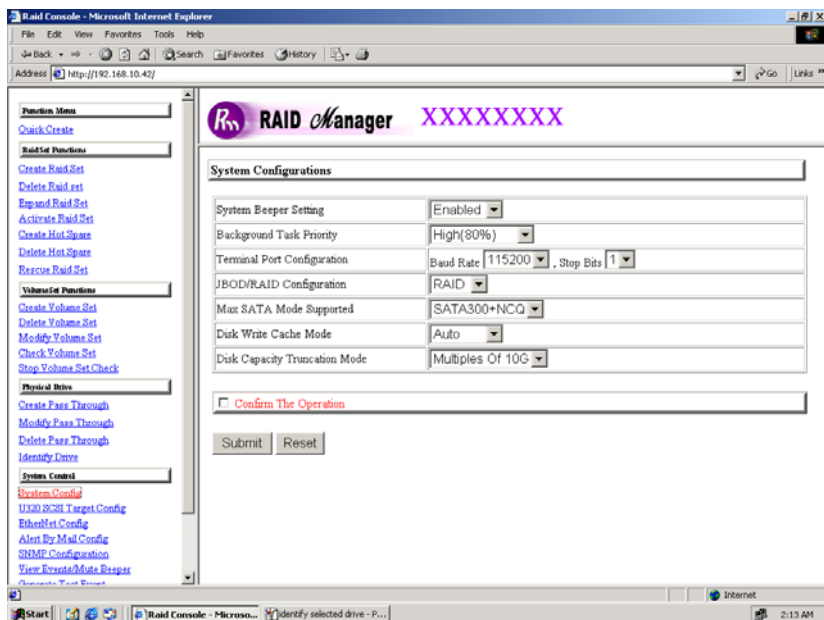

#### System Beeper Setting:

The Alert Beeper function item is used to Disabled or Enable the RAID subsystem controller alarm tone generator.

#### RAID Rebuild Priority:

The Raid Rebuild Priority is a relative indication of how much time the controller devotes to a rebuild operation. The RAID subsystem allows user to choose the rebuild priority (ultraLow, Low, Medium, High) to balance volume set access and rebuild tasks appropriately. For high array performance, specify a Low value.

---

**Terminal Port Configuration:**

Speed setting values are 1200, 2400, 4800, 9600, 19200, 38400, 57600, and 115200.

Stop Bits values are 1 bit and 2 bits.

Note: Parity value is fixed at None.

Data Bits value is fixed at 8 bits.

**JBOD/RAID Configuration**

The RAID subsystem supports JBOD and RAID configuration.

**Maximum SATA Mode Supported:**

The 16 SATA drive channel can support up to SATA II, which runs up to 300MB/s. NCQ is a command protocol in Serial ATA that can only be implemented on native Serial ATA hard drives. It allows multiple commands to be outstanding within a drive at the same time. Drives that support NCQ have an internal queue where outstanding commands can be dynamically rescheduled or re-ordered, along with the necessary tracking mechanisms for outstanding and completed portions of the workload. RAID subsystem allows user to choose the SATA Mode: SATA150, SAT150+NCQ, SAT300, SATA300+NCQ.

**Disk Write Cache Mode:**

The RAID subsystem supports auto, enabled and disabled. When the RAID subsystem with BBM (battery backup module) the auto option will Enable disk write cache. Contrariwise, the auto option will Disable disk write cache.

**Disk Capacity Truncation Mode:**

This RAID subsystem use drive truncation so that drives from differing vendors are more likely to be able to be used as spares for each other. Drive truncation slightly decreases the usable capacity of a drive that is used in redundant units.

**Multiples Of 10G:** If you have 120 GB drives from different vendors; chances are that the capacity varies slightly. For example, one drive might be 123.5 GB, and the other 120 GB. This drive Truncation mode **Multiples Of 10G** uses the same capacity for both of these drives so that one could replace the other.

**Multiples Of 1G:** If you have 123 GB drives from different vendors; chances are that the capacity varies slightly. For example, one drive might be 123.5 GB, and the other 123.4 GB. This drive Truncation mode **Multiples Of 1G** uses the same capacity for both of these drives so that one could replace the other.

**No Truncation:** It does not truncate the capacity.

---

### 3.9.2 U320 SCSI Target Config

To set the U320 SCSI Target function, move the cursor bar to the main menu and click on the **U320 SCSI Target Config**. The Enabled option supports Quick Arbitration and Selection (QAS). QAS reduces the overhead of control release on the SCSI bus from one device to another. This improvement reduces command overhead and maximizes bus utilization. Select the desired function.

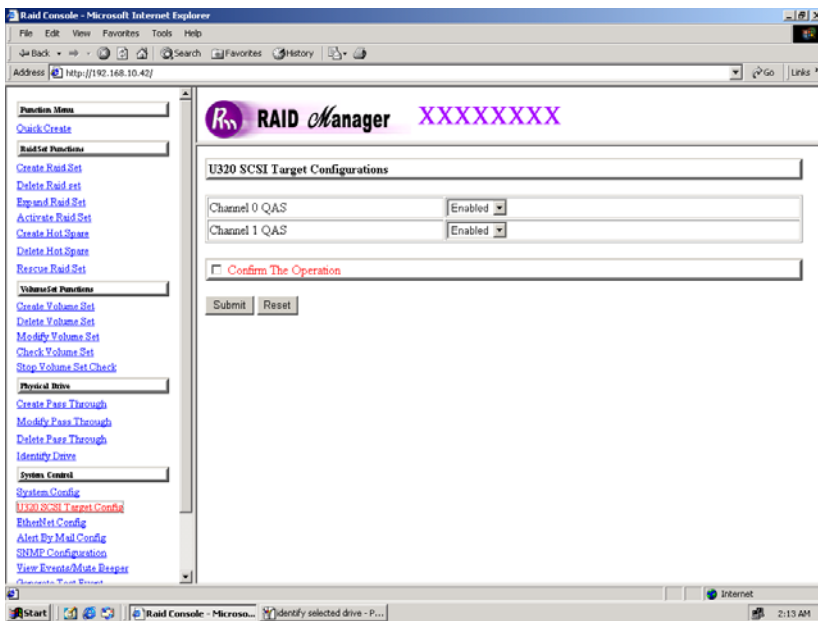

### 3.9.3 EtherNet Config

To set the EtherNet function, move the cursor bar to the main menu and click on the **EtherNet Config**. The Raid System EtherNet Function menu will show all items. Select the desired function.

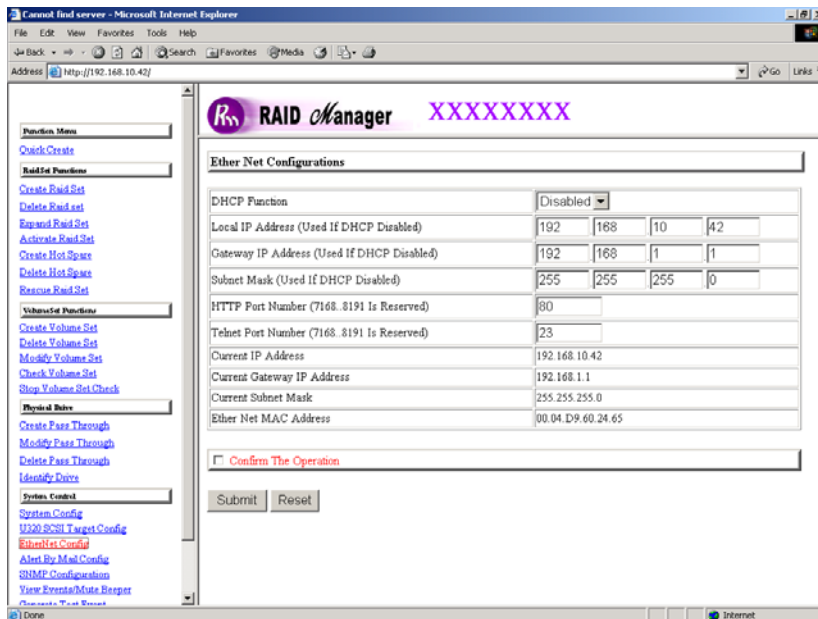

### 3.9.4 Alert By Mail Config

To set the Event Notification function, move the cursor bar to the main menu and click on the **Alert By Mail Config**. The Raid System Event Notification Function menu will show all items. Select the desired function. When an abnormal condition occurs, an error message will be email to administrator that a problem has occurred. Events are classified to 4 levels (urgent, serious, warning, message).

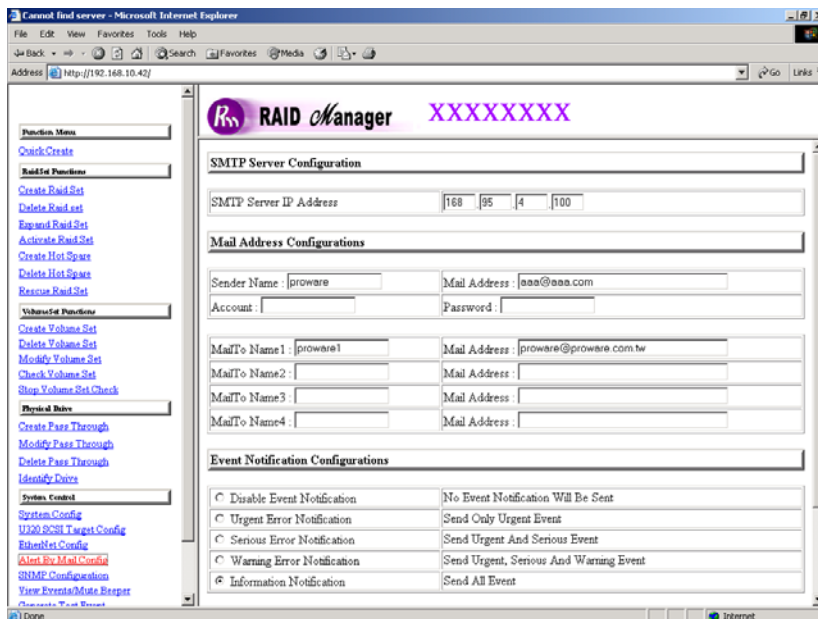

---

### 3.9.5 SNMP Configuration

The SNMP gives users independence from the proprietary network management schemes of some manufacturers and SNMP is supported by many WAN and LAN manufacturers enabling true LAN/ WAN management integration.

To set the SNMP function, move the cursor bar to the main menu and click on he **SNMP Configuration**. The Raid System SNMP Function menu will show all items. Select the desired function.

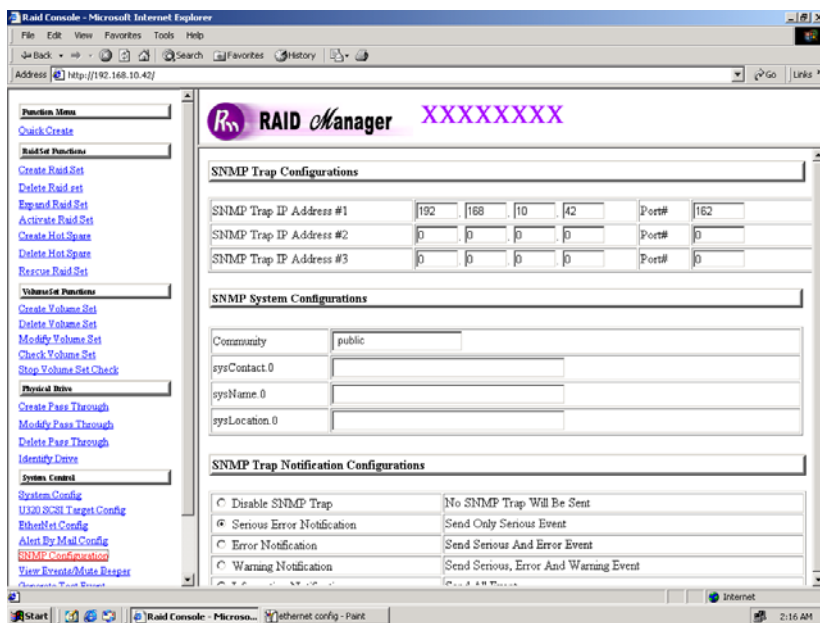

**SNMP Trap Configurations:** Type the SNMP Trap IP Address. The Port default is 162.

#### SNMP System Configuration:

Community: The default is Public.

(1)sysContact.0; (2)sysLocation.0; (3)sysName.0: SNMP parameter (31 bytes max). If this 3 categories are selected during initial setting then when an error occurs SNMP will send out a message that includes the 3 categories within

the message. This allows user to easily define which RAID unit is having problem. Once this setting is done, alert by mail configuration will also work in the same way.

**SNMP Trap Notification Configurations:** Select the desired function.

After you complete the addition, tick on the **Confirm The Operation** and click on the **Submit** button to complete the action.

### 3.9.6 View Events

To view the RAID subsystem controller's information, move the mouse cursor to the main menu and click on the **System Information** link. The Raid Subsystem events Information screen appears.

Choose this option to view the system events information: Timer, Device, Event type, Elapse Time and Errors. The RAID system does not built the real time clock. The Time information is the relative time from the RAID subsystem power on.

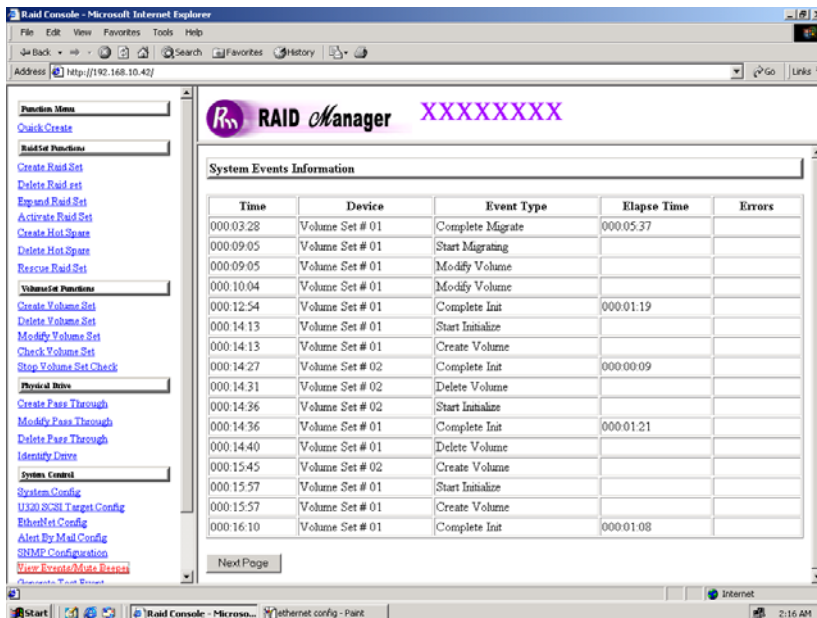

---

### 3.9.7 Generate Test Events

If you want to generate test events, move the cursor bar to the main menu and click on the **Generate Test Events**. Tick on the **Confirm The Operation**, and click on the **Submit** button in the screen to create the hot spares. Then click on the **View Events/Mute Beeper** to view the test event.

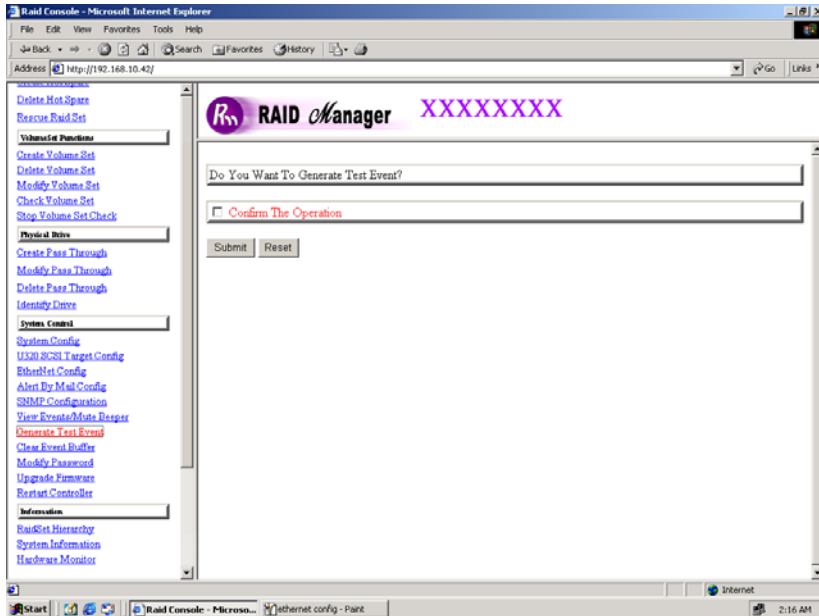



---

The password option allows user to set or clear the raid subsystem's password protection feature. Once the password has been set, the user can only monitor and configure the raid subsystem by providing the correct password.

The password is used to protect the internal RAID subsystem from unauthorized entry. The controller will check the password only when entering the Main menu from the initial screen. The RAID subsystem will automatically go back to the initial screen when it does not receive any command in ten seconds.

To disable the password, press **Enter** key only in both the **Enter New Password** and **Re-Enter New Password** column. Once the user confirms the operation and clicks the **Submit** button. The existing password will be cleared. No password checking will occur when entering the main menu from the starting screen.

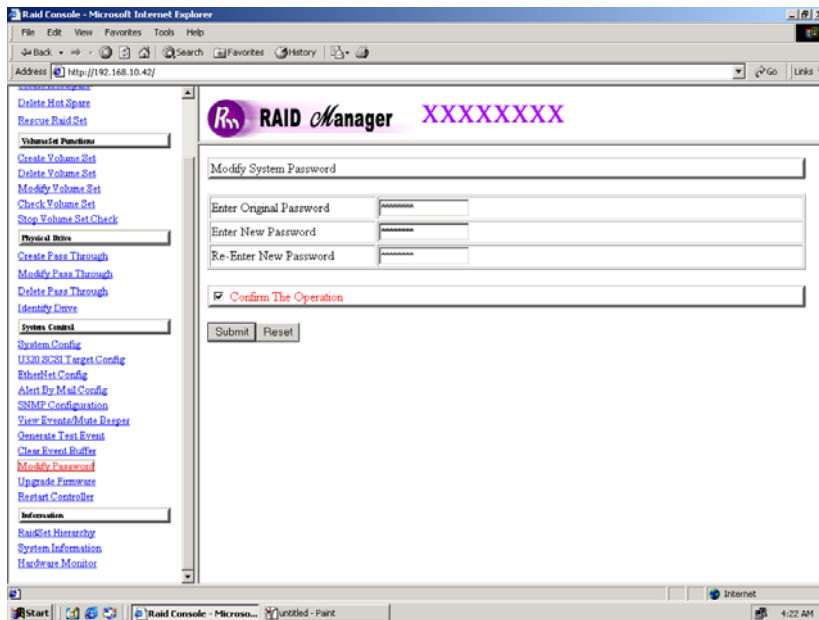

### 3.9.10 Upgrade Firmware

Please reference the section 3.12 for more information.

---

## 3.10 Information Menu

### 3.10.1 RaidSet Hierarchy

Use this feature to view the internal raid subsystem current raid set, current volume set and physical disk configuration.

### 3.10.2 System Information

To view the RAID subsystem controller's information, move the mouse cursor to the main menu and click on the **System Information** link. The Raid Subsystem Information screen appears.

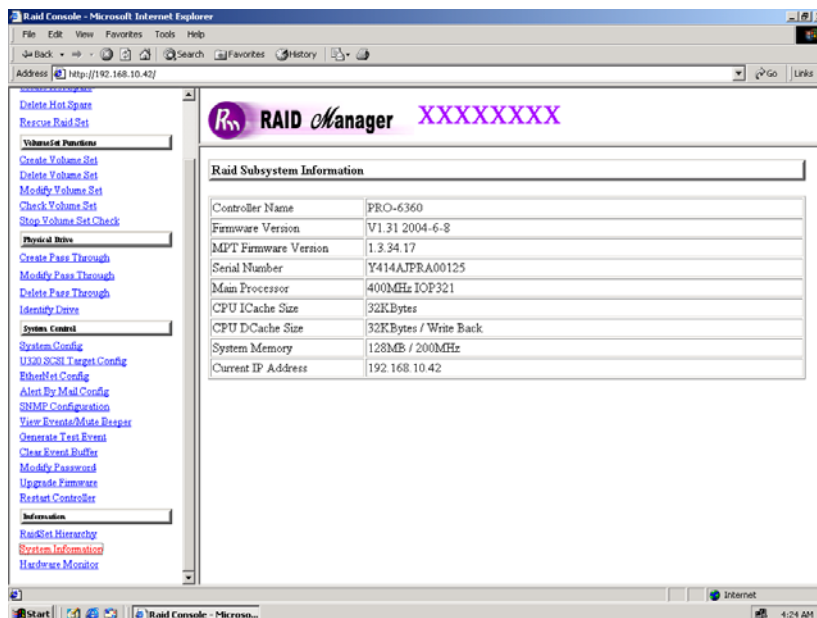

Use this feature to view the raid subsystem controller's information. The controller name, firmware version, serial number, main processor, CPU data/Instruction cache size and system memory size/speed appear in this screen.

### 3.10.3 Hardware Monitor

To view the RAID subsystem controller's hardware monitor information, move the mouse cursor to the main menu and click the **Hardware Monitor** link. The Hardware Information screen appears.

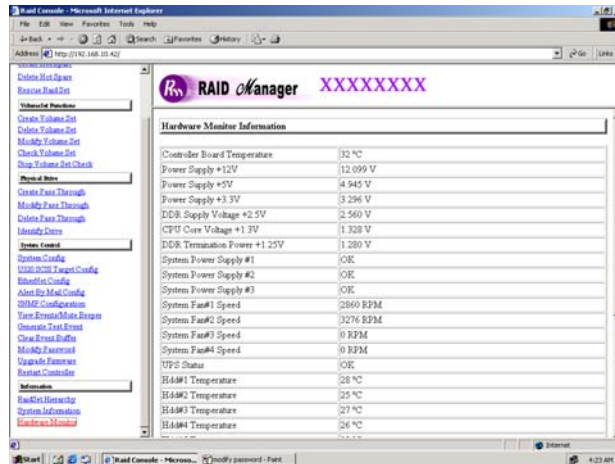

The Hardware Monitor Information provides the temperature, fan speed (chassis fan) and voltage of the internal RAID subsystem. All items are also unchangeable. The warning messages will indicate through the LCD, LED and alarm buzzer.

Item	Warning Condition
Controller Board Temperature	> 60 Celsius
HDD Temperature	> 55 Celsius
Controller Fan Speed	< 2600 RPM
Power Supply +12V	< 10.8V or > 13.2V
Power Supply +5V	< 4.5V or > 5.5V
Power Supply +3.3V	< 2.97V or > 3.63V
DDR Supply Voltage +2.5V	< 2.25V or > 2.75V
CPU Core Voltage +1.3V	< 1.17V or > 1.43V
DDR Termination Power +1.25V	< 1.125V or > 1.375V

---

### **3.11 Creating a New RAID or Reconfiguring an Existing RAID**

You can configure raid sets and volume sets using **Quick Create** or **Raid Set Functions/Volume Set Functions** configuration method. Each configuration method requires a different level of user input. The general flow of operations for raid set and volume set configuration is:

<b>Step</b>	<b>Action</b>
<b>1</b>	Designate hot spares/pass-through (optional).
<b>2</b>	Choose a configuration method.
<b>3</b>	Create raid set using the available physical drives.
<b>4</b>	Define volume set using the space in the raid set.
<b>5</b>	Initialize the volume set and use volume set in the HOST OS.

---

## **3.12 Upgrading the Firmware**

### ***Upgrading Flash Firmware Programming Utility***

Since the RAID subsystem controller features flash firmware, it is not necessary to change the hardware flash chip in order to upgrade the RAID firmware. The user can simply re-program the old firmware through the RS-232 port. New releases of the firmware are available in the form of a DOS file at OEM's FTP. The file available at the FTP site is usually a self-extracting file that contains the following:

XXXXVVV.BIN Firmware Binary (where "XXXX" refers to the model name and "VVV" refers to the firmware version)

README.TXT It contains the history information of the firmware change. Read this file first before upgrading the firmware.

These files must be extracted from the compressed file and copied to one directory in drive A or C.

### ***Establishing the Connection for the RS-232***

The firmware can be downloaded to the RAID subsystem controller by using an ANSI/VT-100 compatible terminal emulation program or Remote web browser management. You must complete the appropriate installation procedure before proceeding with this firmware upgrade. Whichever terminal emulation program is used must support the ZMODEM file transfer protocol.

Configuration of the internal RAID subsystem web browser-based remote RAID management. Web browser-based RAID management can be used to update the firmware. You must complete the appropriate installation procedure before proceeding with this firmware upgrade.

---

## Upgrading Firmware Through ANSI/VT-100 Terminal Emulation

Get the new version firmware for your RAID subsystem controller. For Example, download the bin file from your OEM's web site onto the c:

1. From the Main Menu, scroll down to "Raid System Function"
2. Choose the "Update Firmware", The Update The Raid Firmware dialog box appears.

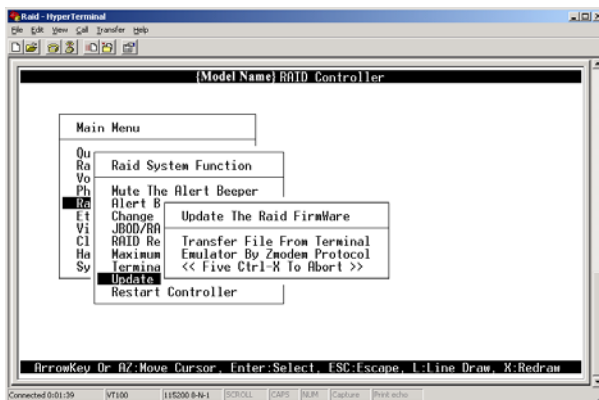

3. Go to the tool bar and select Transfer. Open Send File.

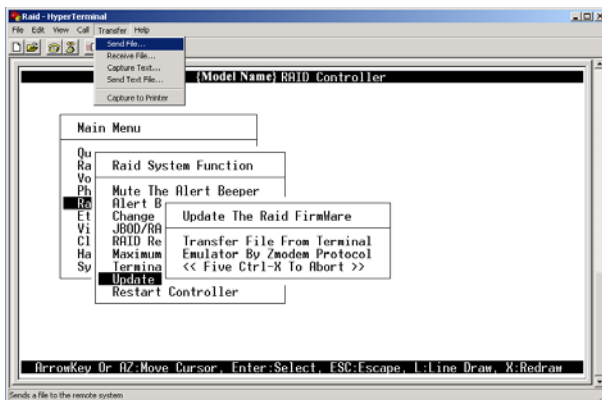

- 
4. Select “ZMODEM modem” under Protocol. ZMODEM as the file transfer protocol of your terminal emulation software.
  5. Click Browse. Look in the location where the Firmware upgrade software is located. Select the File name: “6160FIRM.BIN” and click open.

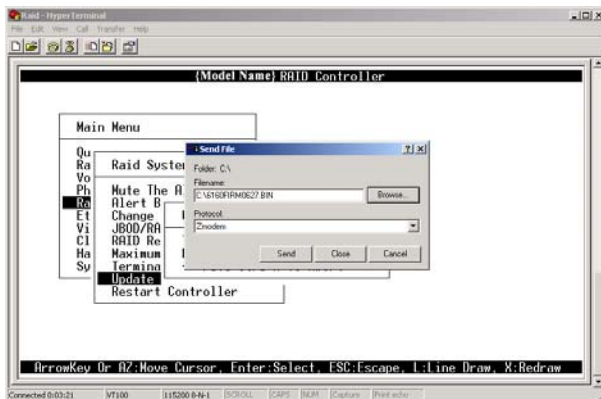

6. Click Send. Send the Firmware Binary to the controller

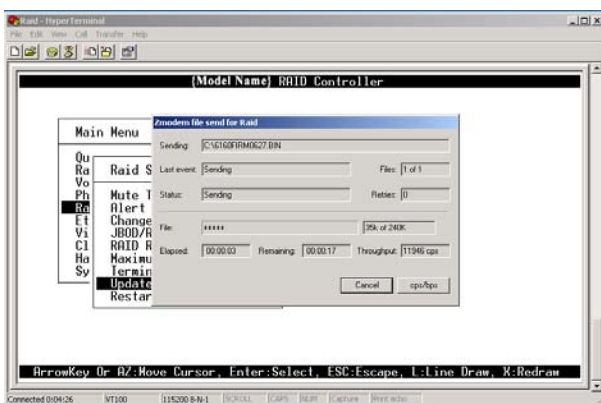

7. When the Firmware completes downloading, the confirmation screen appears. Press **Yes** to start program the flash ROM.

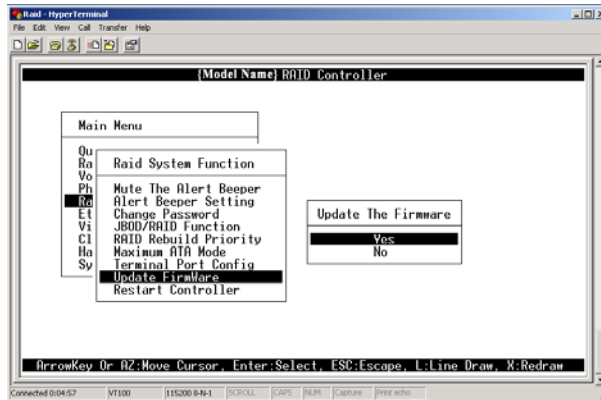

8. When the Flash programming starts, a bar indicator will show "Start Updating Firmware. Please Wait."

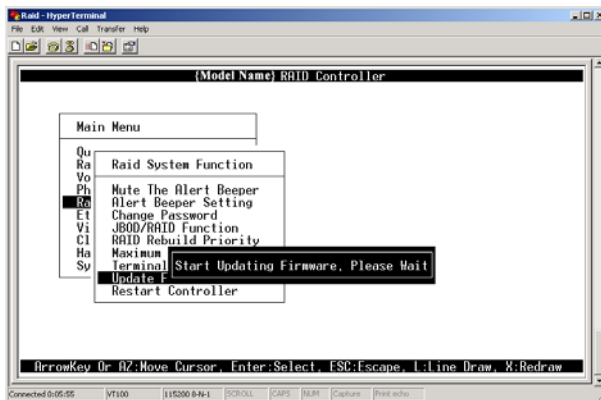

9. The Firmware upgrade will take approximately thirty seconds to complete.

10. After the Firmware upgrade is complete, a bar indicator will show “ Firmware Has Been Updated Successfully”.

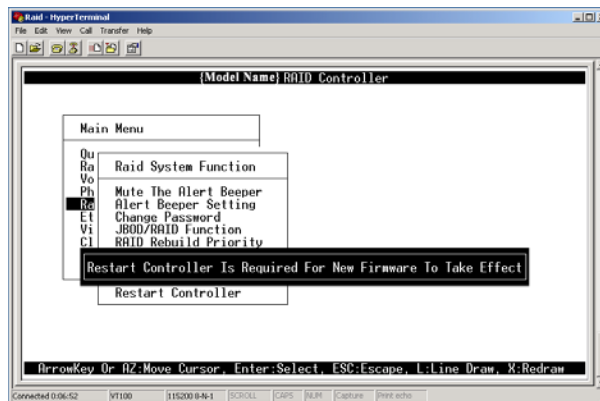
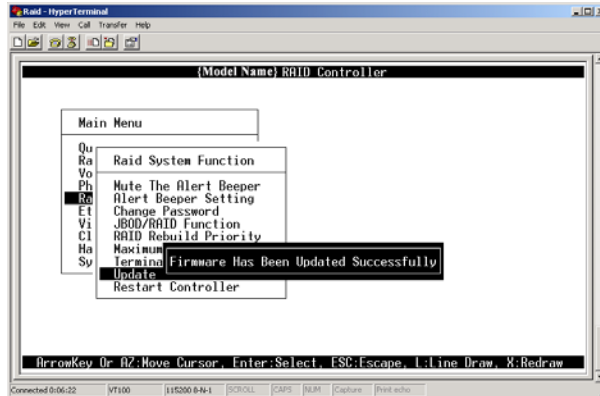

**NOTE:**

The user has to reconfigure all of the settings after the firmware upgrade is complete, because all of the settings will default to the original default values.

---

## Upgrading Firmware Through Web Browser Management

Get the new version firmware for your RAID subsystem controller.

1. To upgrade the RAID subsystem firmware, move the cursor to **Upgrade Firmware** link. The **Upgrade The Raid System Firmware** screen appears.
2. Click Browse. Look in the location where the Firmware upgrade software is located. Select the File name: “6160FIRM.BIN” and click open.
3. Click the **Confirm The Operation** and press the **Submit** button.

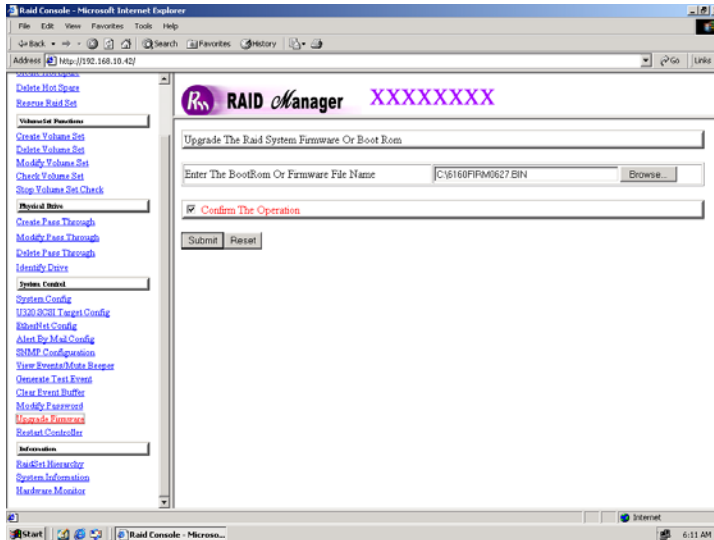

4. The Web Browser begins to download the firmware binary to the controller and start to update the flash ROM.

- 
5. After the firmware upgrade is complete, a bar indicator will show “Firmware Has Been Updated Successfully”

